

**20MM OUTDOOR  
PORCELAIN TILES**  
COLLECTION - 2023-'24

**WIN-TEL**  
DIGITAL VITRIFIED TILES



**20MM OUTDOOR  
PORCELAIN TILES**  
COLLECTION - 2023-'24

**WIN-TEL**  
DIGITAL VITRIFIED TILES

**A CONFLUENCE OF  
NATURE & TECHNOLOGY**





**20MM OUTDOOR  
PORCELAIN TILES**

**DISCOVER THE COLLECTION OF RESILIENT SURFACES CRAFTED WITH THE CONVERGENCE OF NATURE AND TECHNOLOGY FOR DEMANDING OUTDOORS AND AREAS THAT ARE AN EXTENSION OF YOUR HOMES AND SPACES.**

The outdoors of your homes and spaces are the first impression that you make on your guests and they are also the places that endure the most. Keeping in mind the aesthetics, functionality, and resilience your outdoor spaces require, Our is here with an exclusive collection of outdoor tiles which is packed with superior aesthetics, endurance, and functionality that will not let you compromise on the outdoor tiling of

your spaces and transform those areas in practical and presentable spaces. The exclusive collection offers outdoor colorbody tiles in robust 20mm thickness and four versatile sizes 600x1200mm, 600x900mm, 600x600mm, and 400x800mm that cater to every tiling need. Packed with a plethora of features the collection blends strength, style, and resilience in your spaces.

600x  
600mm

600x  
1200mm

400x  
800mm

600x  
900mm

# TILE LAYING POSSIBILITIES

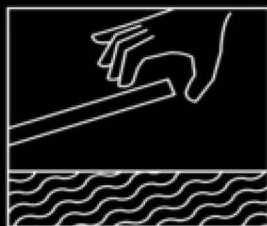

## LAYING ON SCREED WITH ADHESIVES



**Laying on screed with adhesives**  
Lay the 20mm outdoor tiles on a bed of screed with adhesives for heavy traffic areas like parking, courtyards, and others like swimming pool borders, outdoor flooring, sit-out areas, and more.

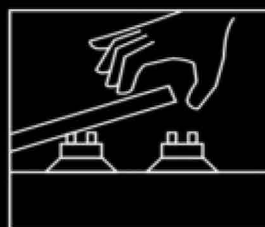

## LAYING ON A RAISED FLOOR

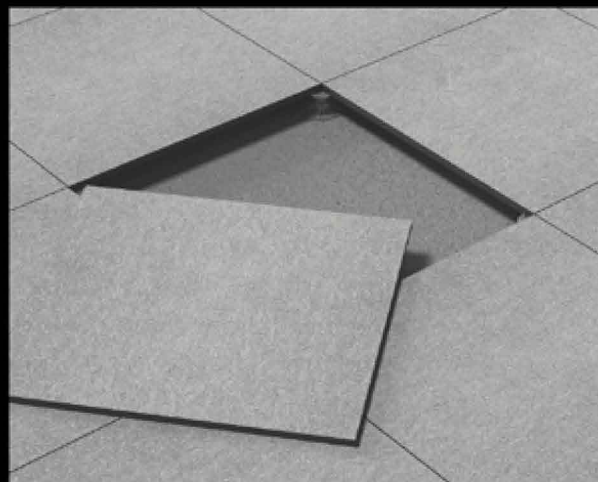

Tile uneven areas, terrains, and more and transform them enduring by laying 20mm outdoor tiles on raised floor pedestals, frames, and more. Create room for a heating system, insulation, additional raised area, and more with the extensive laying possibilities of this collection.

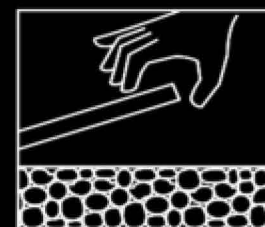

## LAYING ON GRAVEL



The robust and resilient collection is ideal for laying directly on gravel in your outdoors with or without adhesive. Create a stepping stone path, patio, and more by just laying the thick tiles on the gravel in your outdoors.



## DRY LAYING ON THE GRASS

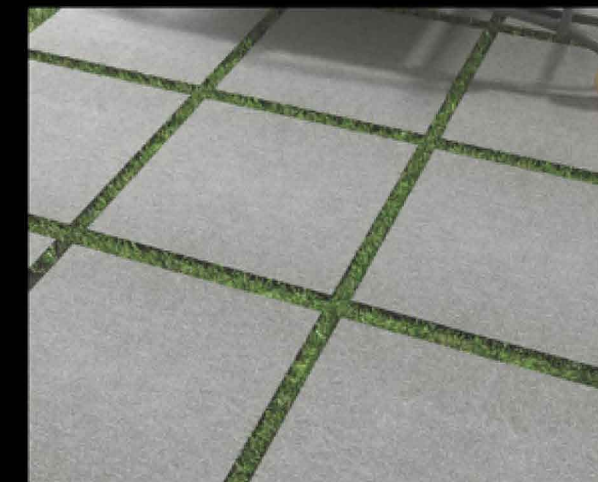

Shape elegant pathways, outdoor leisure areas, and more by dry laying the 20mm outdoor tiles on the grass in your gardens and other areas surrounding the building. The laying possibility opens door to fuss-free outdoor tiling.



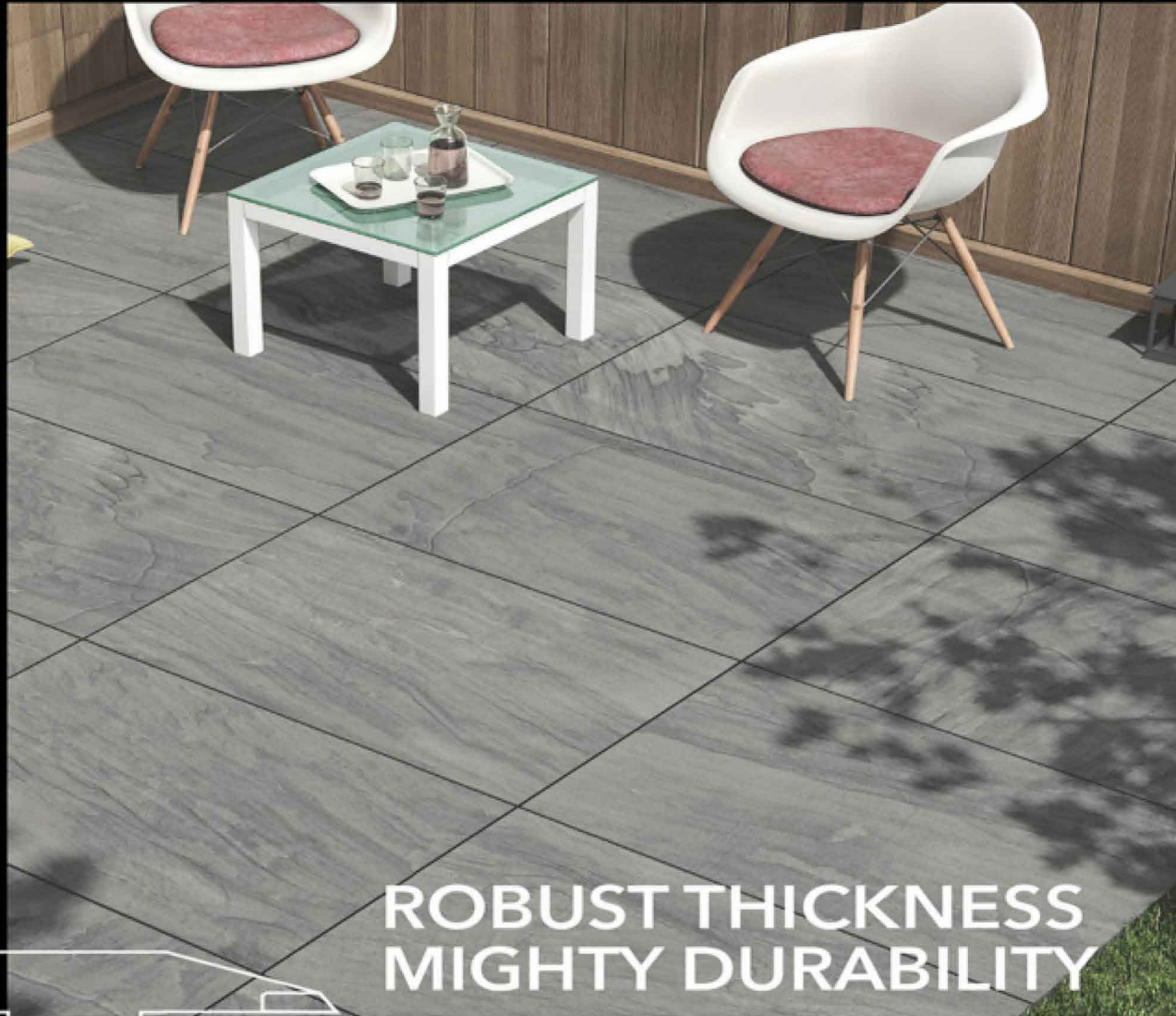



# BENIFITS OF 20MM OUTDOOR TILES

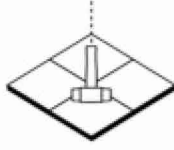
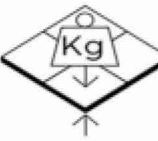

**ROBUST THICKNESS  
MIGHTY DURABILITY**

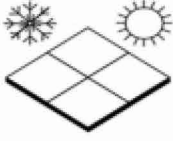
**20MM**

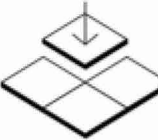
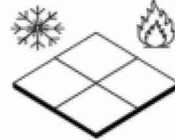
The substantial thickness of 20mm of the collection lends the surfaces exceptional durability and resilience. The thickness offers surfaces durability to endure heavy traffic, weight, and rugged use and makes the surfaces practically ideal for all kinds of usages. The thickness paired with R11 anti-skid surfaces makes the surfaces of the collection extremely safe for use outdoors.

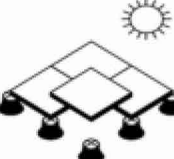
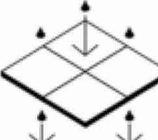
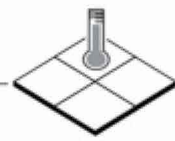
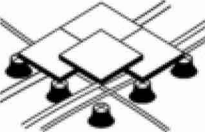
 <p>Stress-resistant</p>	 <p>High tensile strength</p>	 <p>Antislip (R11)</p>	 <p>Weather resistant</p>
 <p>Easy to clean due to the lack of adhesives and filler</p>	 <p>Easy to install even without adhesives or filler</p>	 <p>Frost and fire-resistant</p>	 <p>Removable and reusable</p>
 <p>Ideal for paving outdoor installations, including raised paving.</p>	 <p>Good drainage, facilitates the flow of water and rainfall, eliminating harmful stagnation</p>	 <p>Highly resistant to changes in temperature</p>	 <p>Easily inspected and functional, allows installation and maintenance of cabling and pipework.</p>

The robustly crafted collection comes with a plethora of features and benefits and aids in an effortless and risk-free lifestyle with attributes like r11 anti-slip surfaces, resistance to heat, frost, fire, weather, stains, and more, and also very easy to maintain. On top of features, the surfaces are easy to install, removable, and reusable.

# APPLICATIONS AND SOLUTIONS

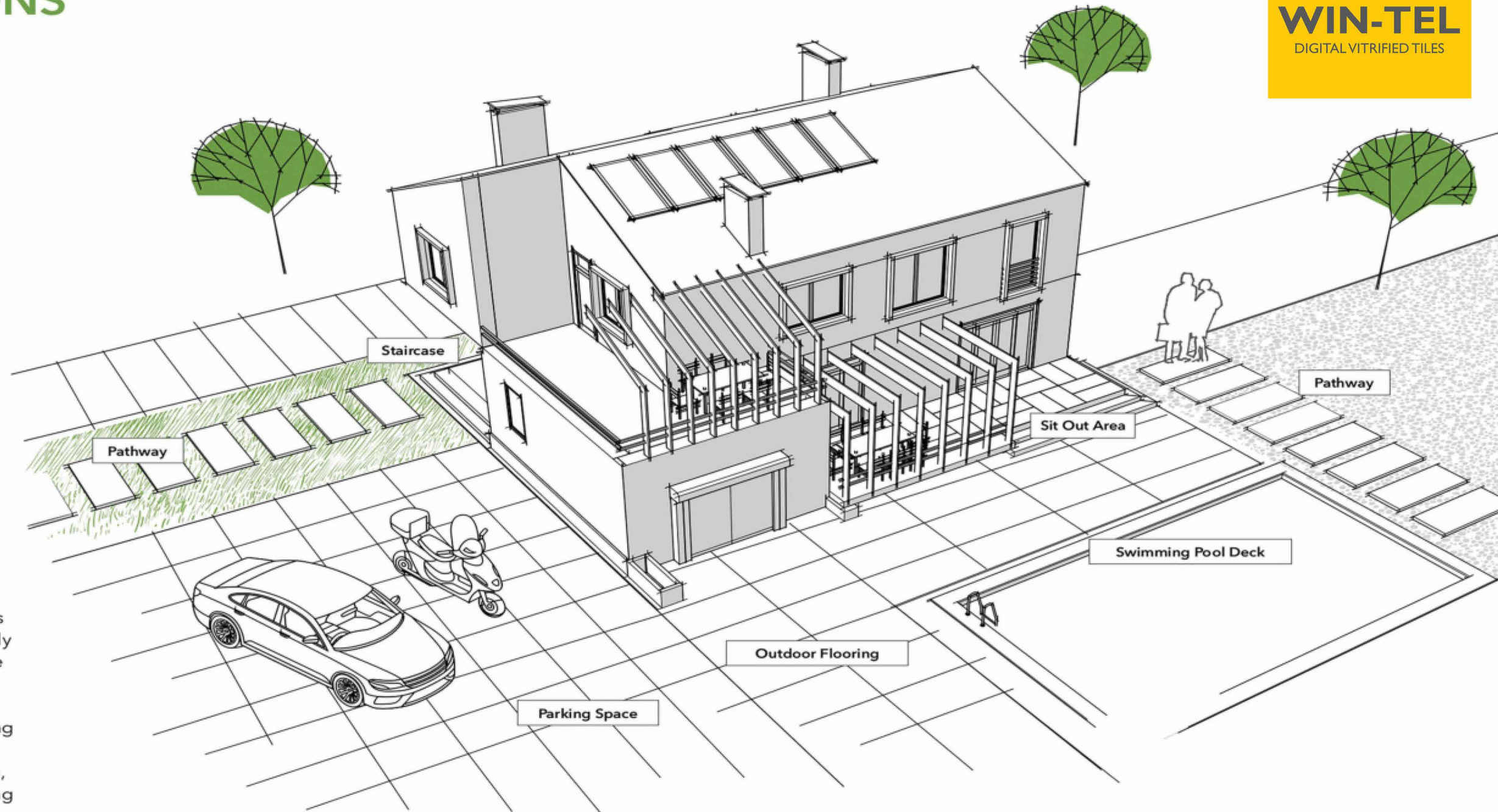

## DESIGN YOUR OUTDOOR SPACES

The extensive application possibilities of the collection allow you to elegantly and practically tile your outdoors. The versatile and extremely durable collection due to its functional characteristics is ideal for tiling parking spaces, outdoor floors, staircases, pathways, benches, outdoor furniture, pavements, patios, gardens, swimming pool decks, and more.

Enjoy your outdoor worry-free with the superior blend of strength and aesthetics of the 20mm outdoor collection of Our crafted to help you appreciate your outdoors.

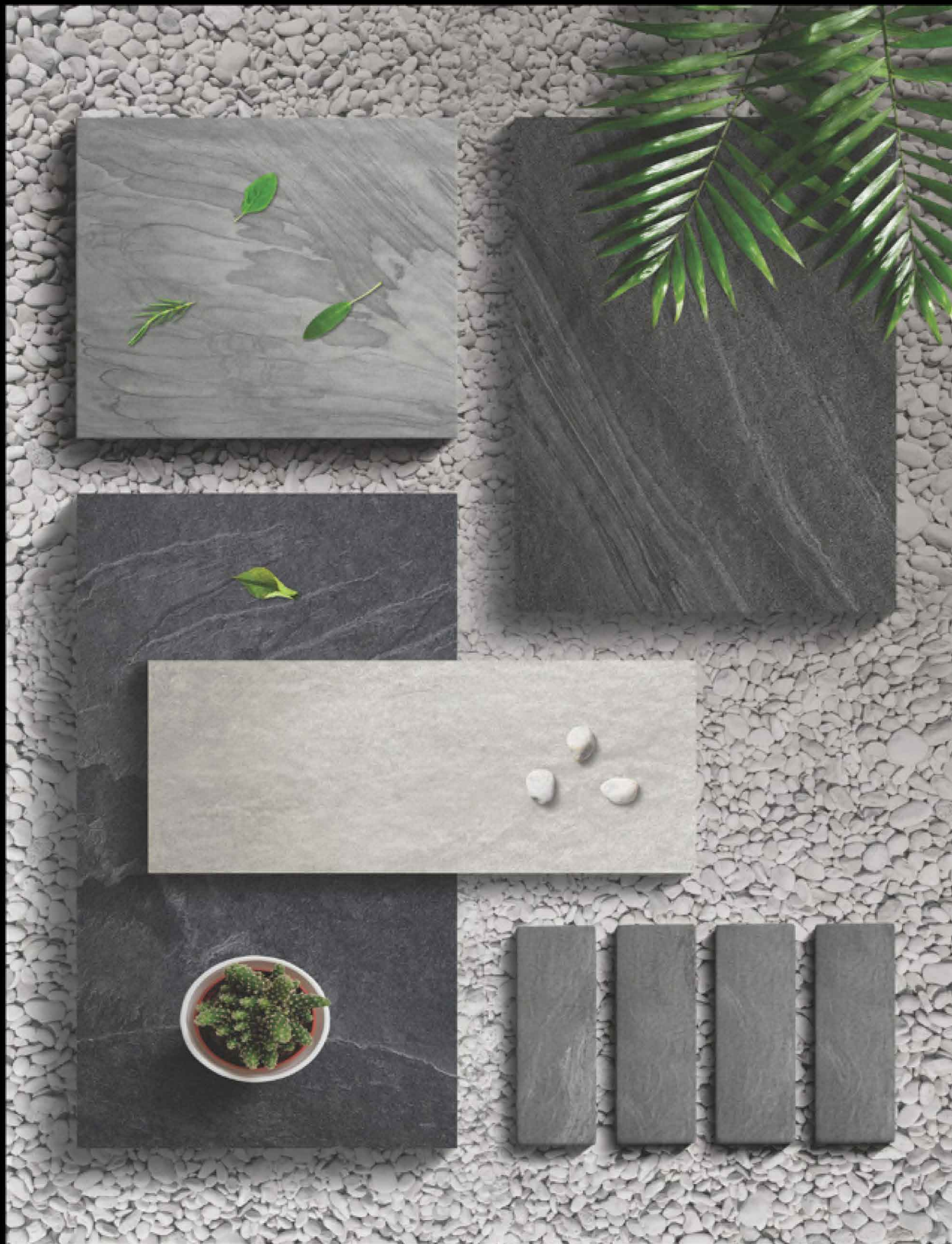

# APPLICATION AREAS

**WIN-TEL**  
DIGITAL VITRIFIED TILES



Public Parks & Gardens



Terraces & Balconies

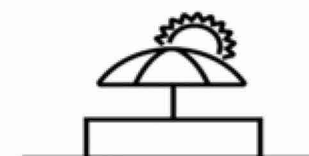

Beach Resorts



Parking Lots

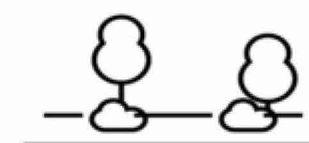

Driveways & Pathways

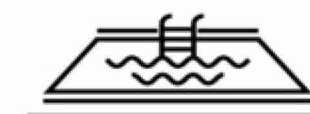

Swimming Pool Decks



Street Furniture



High-Traffic Industrial Areas

# LAYING PATTERNS



**ACHIEVE VISUALLY APPEALING OUTDOORS WITH MULTIPLE LAYING PATTERN POSSIBILITIES.**

Explore extensive tile-laying pattern possibilities with the multiple sizes of the 20mm outdoor tile collection. The four different sizes of the collection allow you to mix and match tile sizes for a unique lay in your spaces. Mix two or

more sizes and spruce up your tiling game outdoors with the elegant tile-laying combination possibilities with the versatile tile sizes and robust thickness of the collection ideal for reusing and relocating tiles.

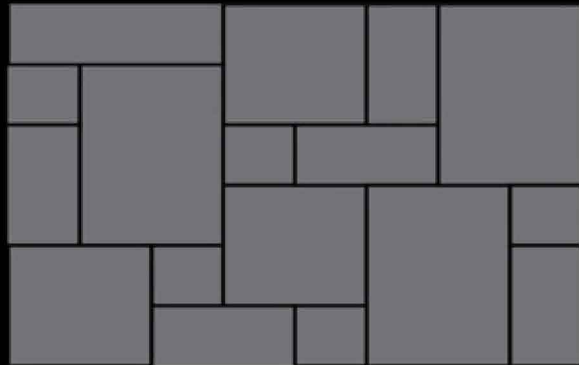

Tiles Combination  
600x900mm, 600x600mm, 300x600mm, 300x300mm

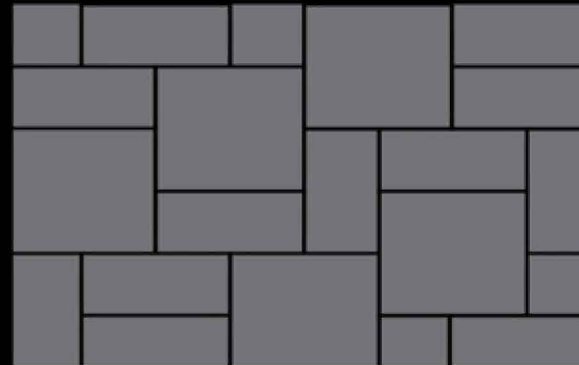

Tiles Combination  
600x600mm, 300x600mm

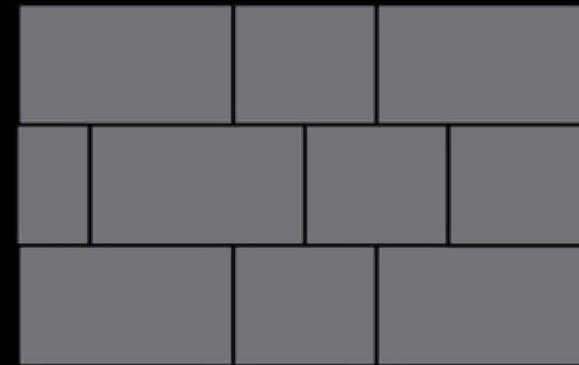

Tiles Combination  
600x900mm, 600x600mm

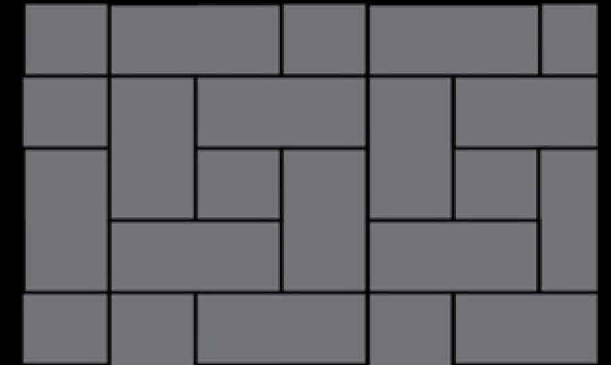

Tiles Combination  
600x1200mm, 600x600mm

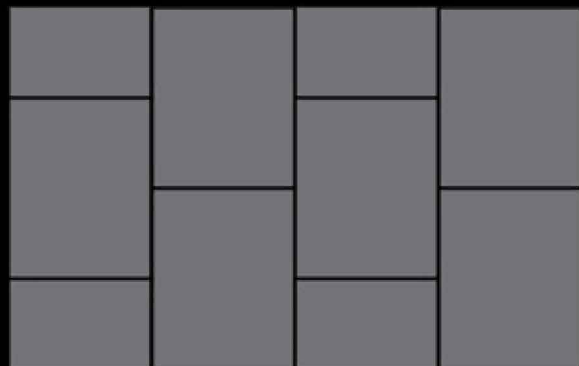

Tiles Combination  
600x900mm

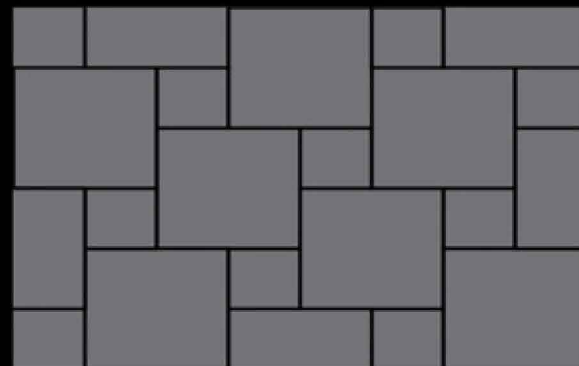

Tiles Combination  
600x600mm, 300x300mm

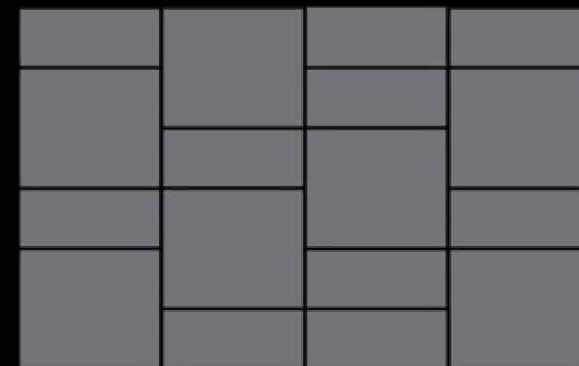

Tiles Combination  
600x600mm, 300x600mm

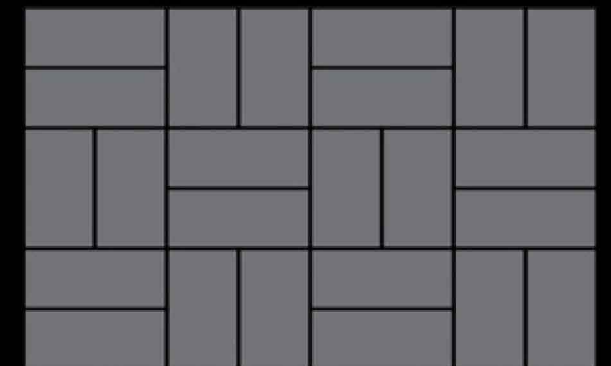

Tiles Combination  
300x600mm



LUCIDO GREY



600x1200 MM



600x900 MM

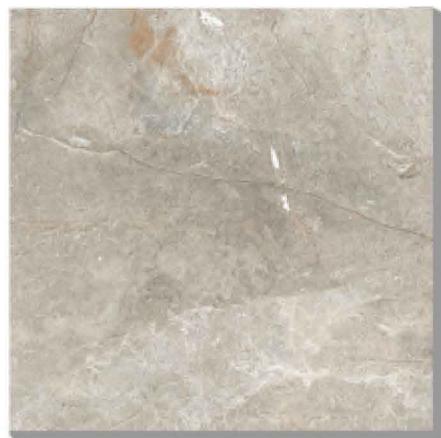

600x600 MM

800x800 MM

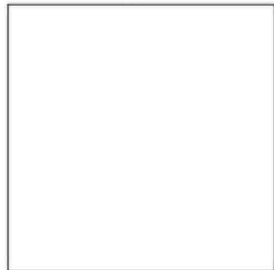

DIFFERENT SIZES

400x800 MM



COBBLES, BULLNOSE

300x600 MM

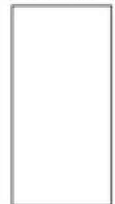

300x300 MM



100x200 MM



100x100 MM



300x1200 MM



200x1200 MM



300x900 MM



200x900 MM



STRIPS

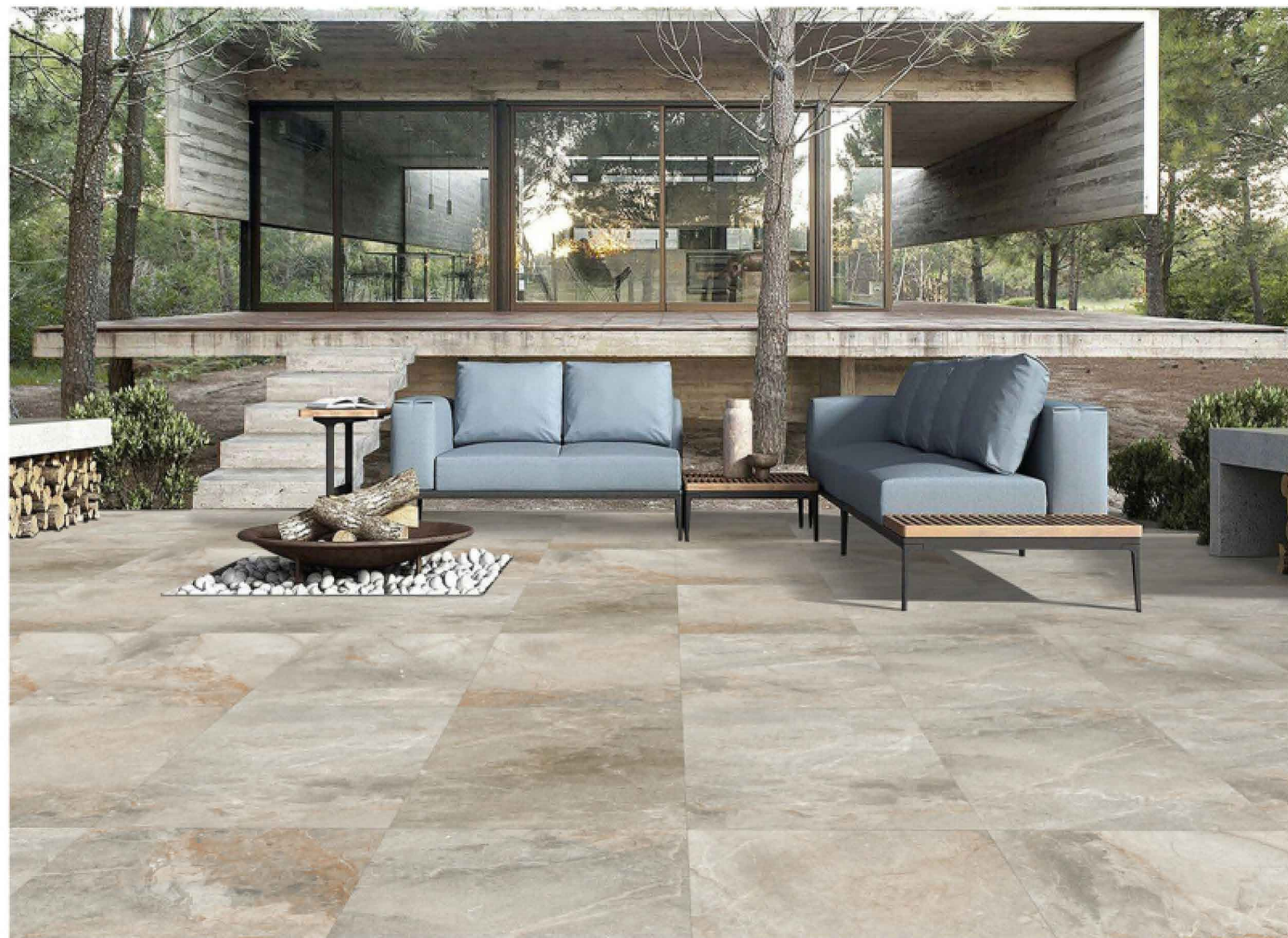

**20MM OUTDOOR  
PORCELAIN TILES**



LUCIDO GREY-600X900 MM

20  
MM  
THICKNESS



**R11**

MADEIRA BEIGE



600x1200 MM

600x900 MM

600x600 MM

800x800 MM

400x800 MM

300x600 MM

300x300 MM

100x200 MM

100x100 MM

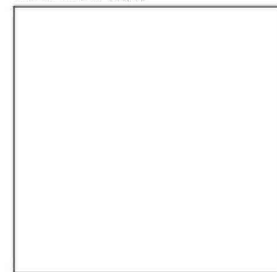

DIFFERENT SIZES



COBBLES, BULLNOSE

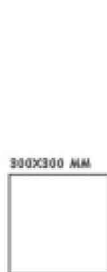

STRIPS

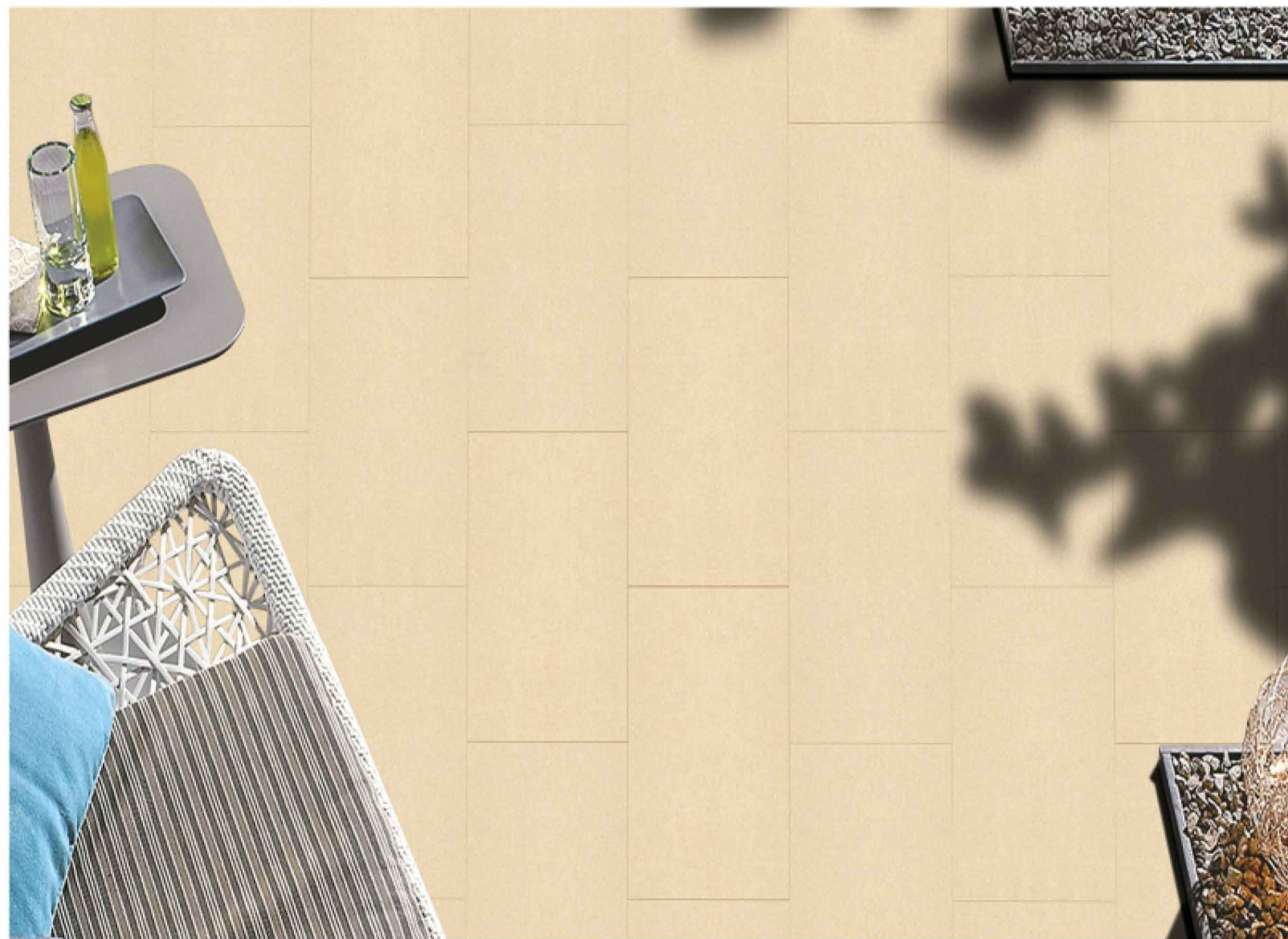

**20MM OUTDOOR  
PORCELAIN TILES**



MADEIRA BEIGE-600X900 MM

20  
MM  
THICKNESS

R11

MADEIRA GREY

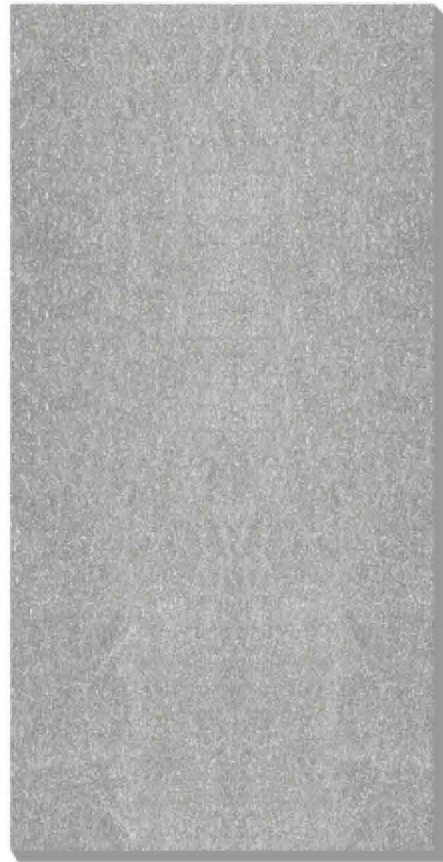

600x1200 MM

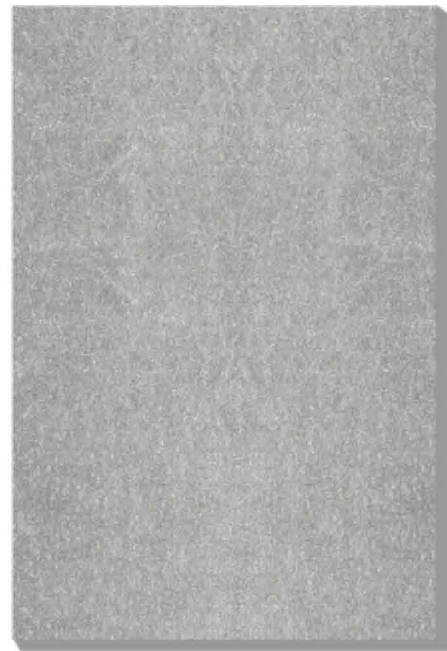

600x900 MM

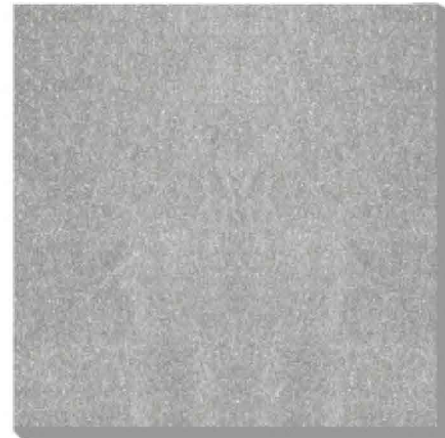

600x600 MM

800x800 MM

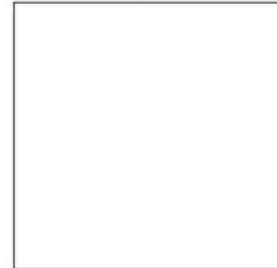

DIFFERENT SIZES

400x800 MM



COBBLES, BULLNOSE

300x600 MM



300x300 MM



100x200 MM

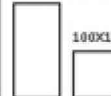

100x100 MM



300x1200 MM



200x1200 MM



300x900 MM



200x900 MM



STRIPS



**20MM OUTDOOR  
PORCELAIN TILES**



MADEIRA GREY-600X900 MM

20  
MM  
THICKNESS



**R11**

**MERAKI BLANCA**

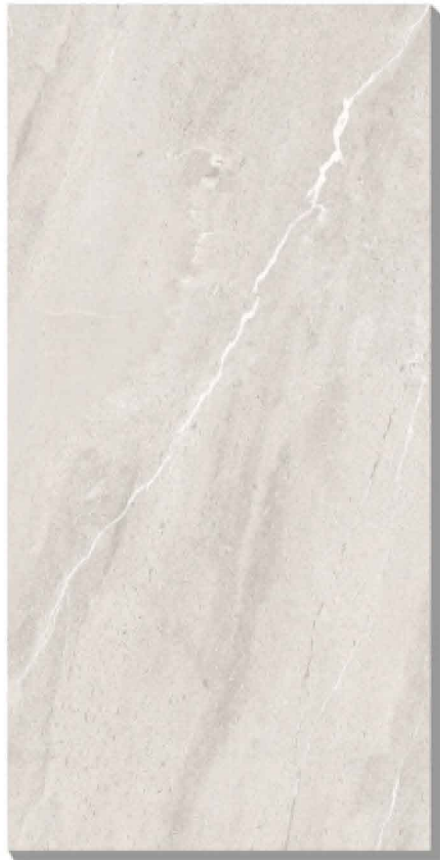

600x1200 MM



600x900 MM



600x600 MM



DIFFERENT SIZES

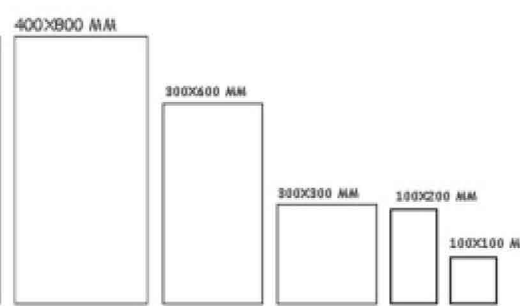

COBBLES, BULLNOSE

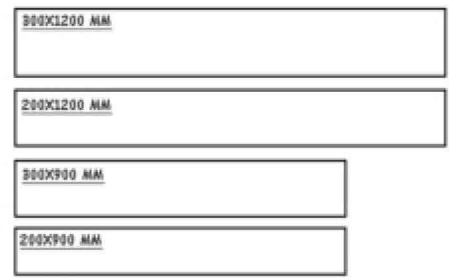

STRIPS



**20MM OUTDOOR  
PORCELAIN TILES**

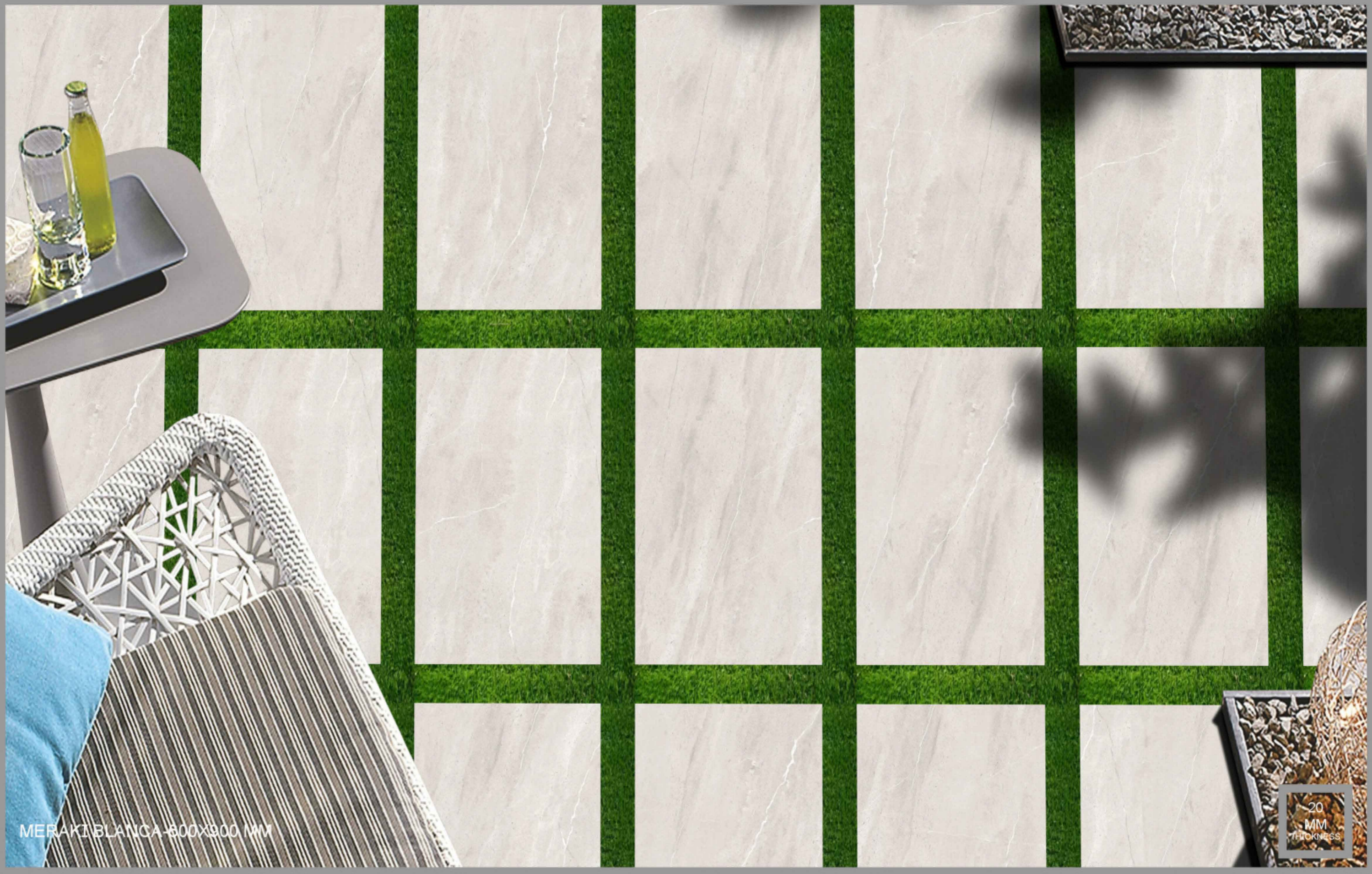

MERAKI BLANCA - 800X800 MM

20  
MM  
THICKNESS





**R11**

MERAKI CREMA



600x1200 MM

600x900 MM

600x600 MM

800x800 MM

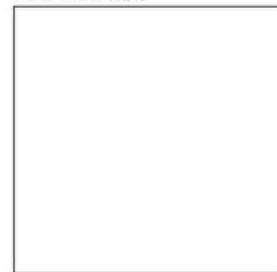

DIFFERENT SIZES

400x800 MM



COBBLES, BULLNOSE

300x600 MM



300x300 MM



100x200 MM



100x100 MM



300x1200 MM



200x1200 MM



300x900 MM



200x900 MM



STRIPS

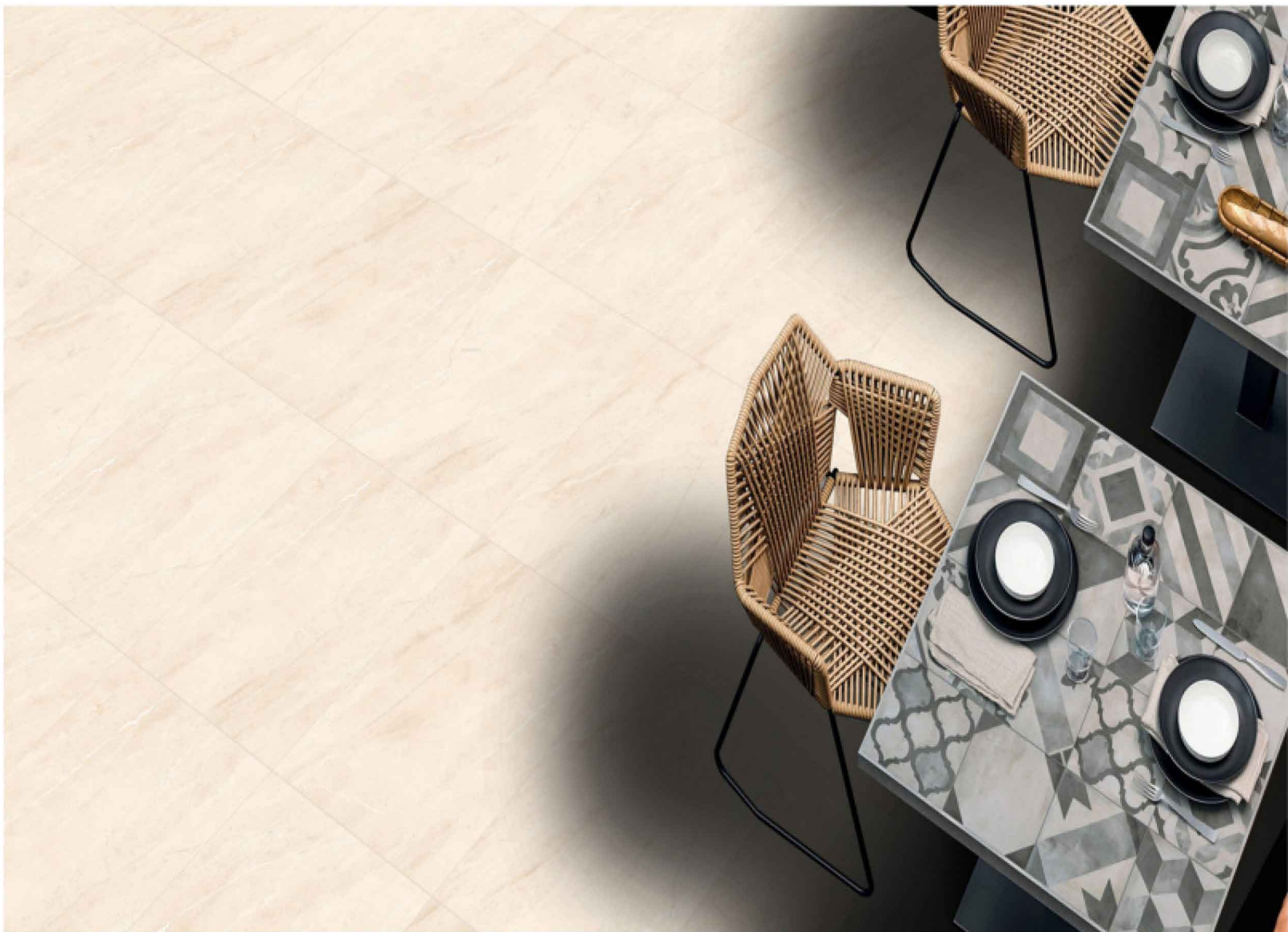

**20MM OUTDOOR  
PORCELAIN TILES**



MERAKI CREMA-600X600 MM

20  
MM  
THICKNESS



**R11**

MIAMI BLACK

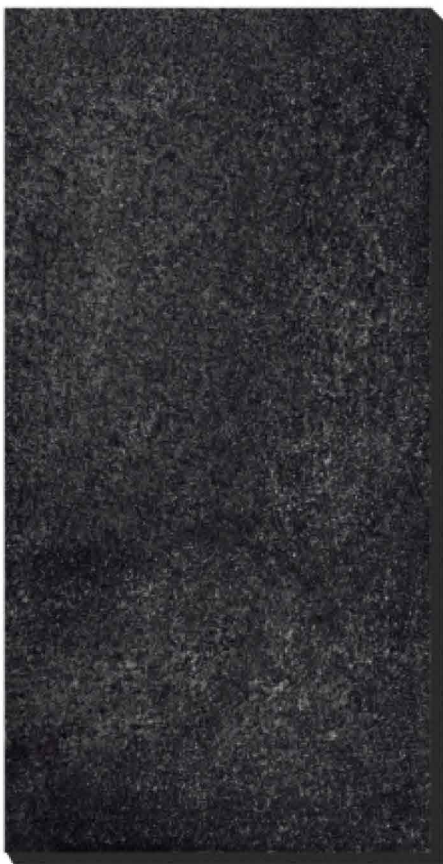

600x1200 MM



600x900 MM



600x600 MM

800x800 MM

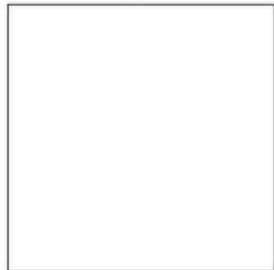

DIFFERENT SIZES

400x800 MM



COBBLES, BULLNOSE

300x600 MM



300x300 MM



100x200 MM



100x100 MM



300x1200 MM



200x1200 MM



300x900 MM



200x900 MM



STRIPS



**20MM OUTDOOR  
PORCELAIN TILES**



MIAMI BLACK-600X600 MM

20  
MM  
THICKNESS



**R11**

MIAMI PEARL GREY

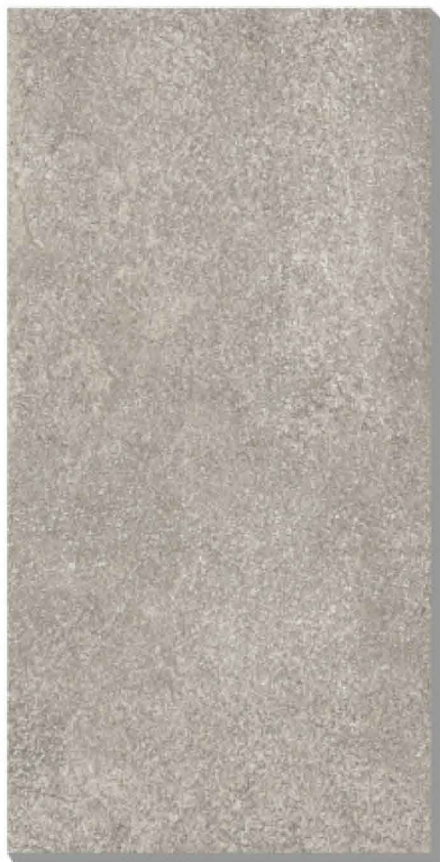

600x1200 MM



600x900 MM



600x600 MM

800x800 MM

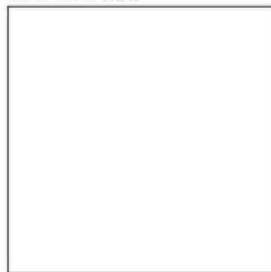

DIFFERENT SIZES

400x800 MM



COBBLES, BULLNOSE

300x600 MM



300x300 MM



100x200 MM



100x100 MM



800x1200 MM



200x1200 MM



300x900 MM



200x900 MM



STRIPS

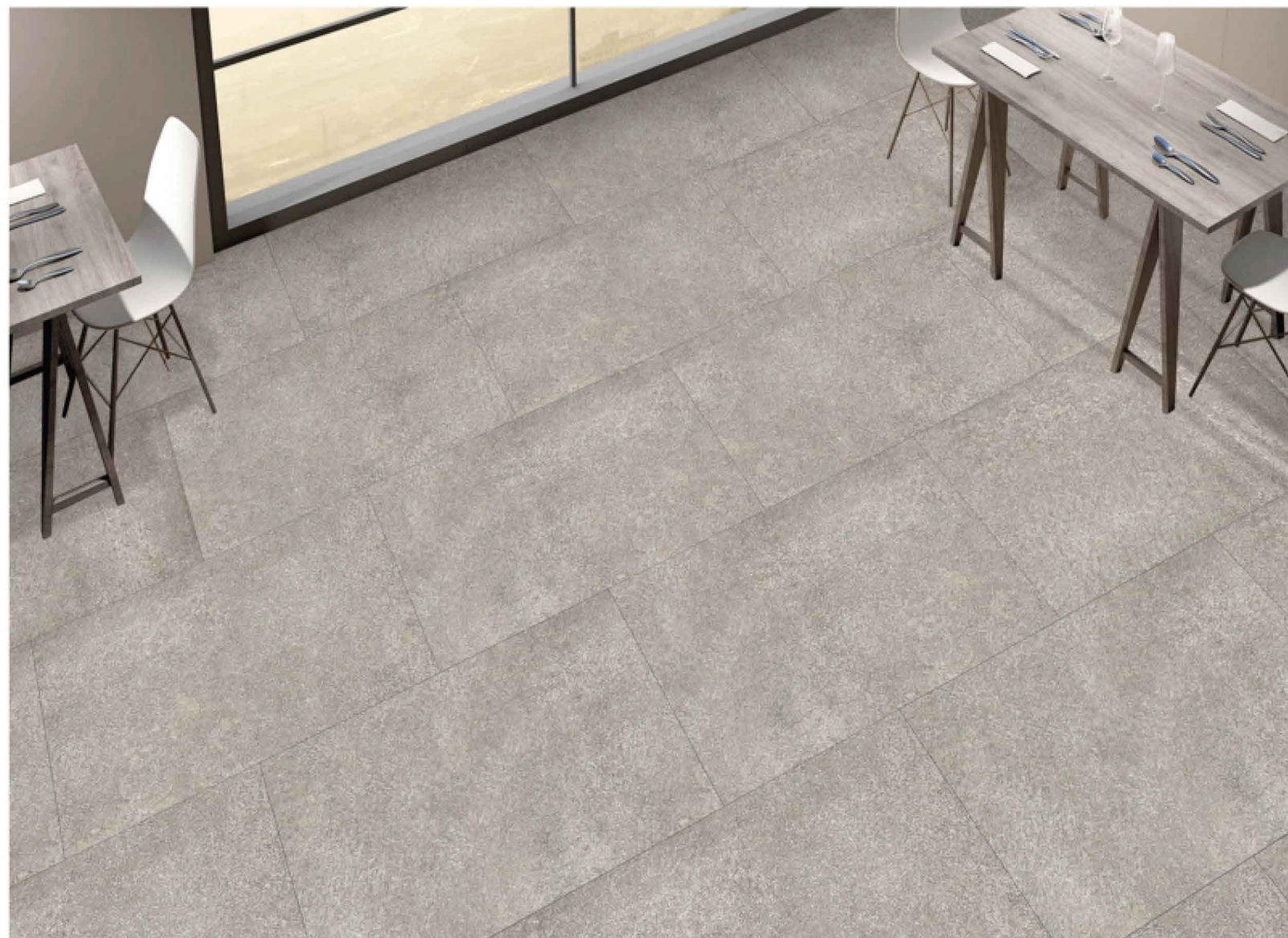

**20MM OUTDOOR  
PORCELAIN TILES**



MIAMI PEARL GREY-600X600 MM

20  
MM  
THICKNESS



**R11**

NEST CREMA



600x1200 MM

600x900 MM

600x600 MM

800x800 MM

400x800 MM

300x600 MM

300x300 MM

100x200 MM

100x100 MM

800x1200 MM

200x1200 MM

300x900 MM

200x900 MM

DIFFERENT SIZES

COBBLES, BULLNOSE

STRIPS



**20MM OUTDOOR  
PORCELAIN TILES**



NEST CREMA-600X900 MM

20  
MM  
THICKNESS





**R11**

NEST WHITE



600x1200 MM

600x900 MM

600x600 MM

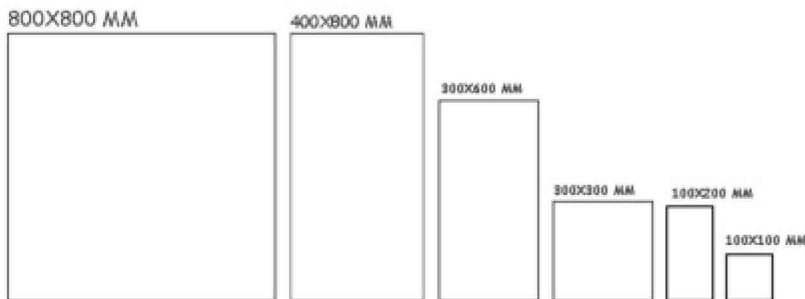

DIFFERENT SIZES

COBBLES, BULLNOSE

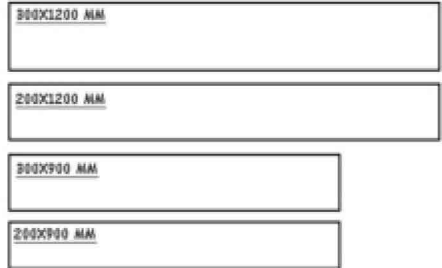

STRIPS



**20MM OUTDOOR  
PORCELAIN TILES**



NEST WHITE-600X600 MM

20  
MM  
THICKNESS

NEWTON GREY



600x1200 MM



600x900 MM



600x600 MM

800x800 MM

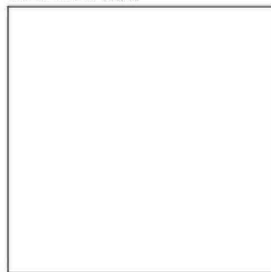

DIFFERENT SIZES

400x800 MM



COBBLES, BULLNOSE

300x600 MM



300x300 MM



100x200 MM

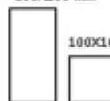

100x100 MM



300x1200 MM



200x1200 MM



300x900 MM



200x900 MM



STRIPS

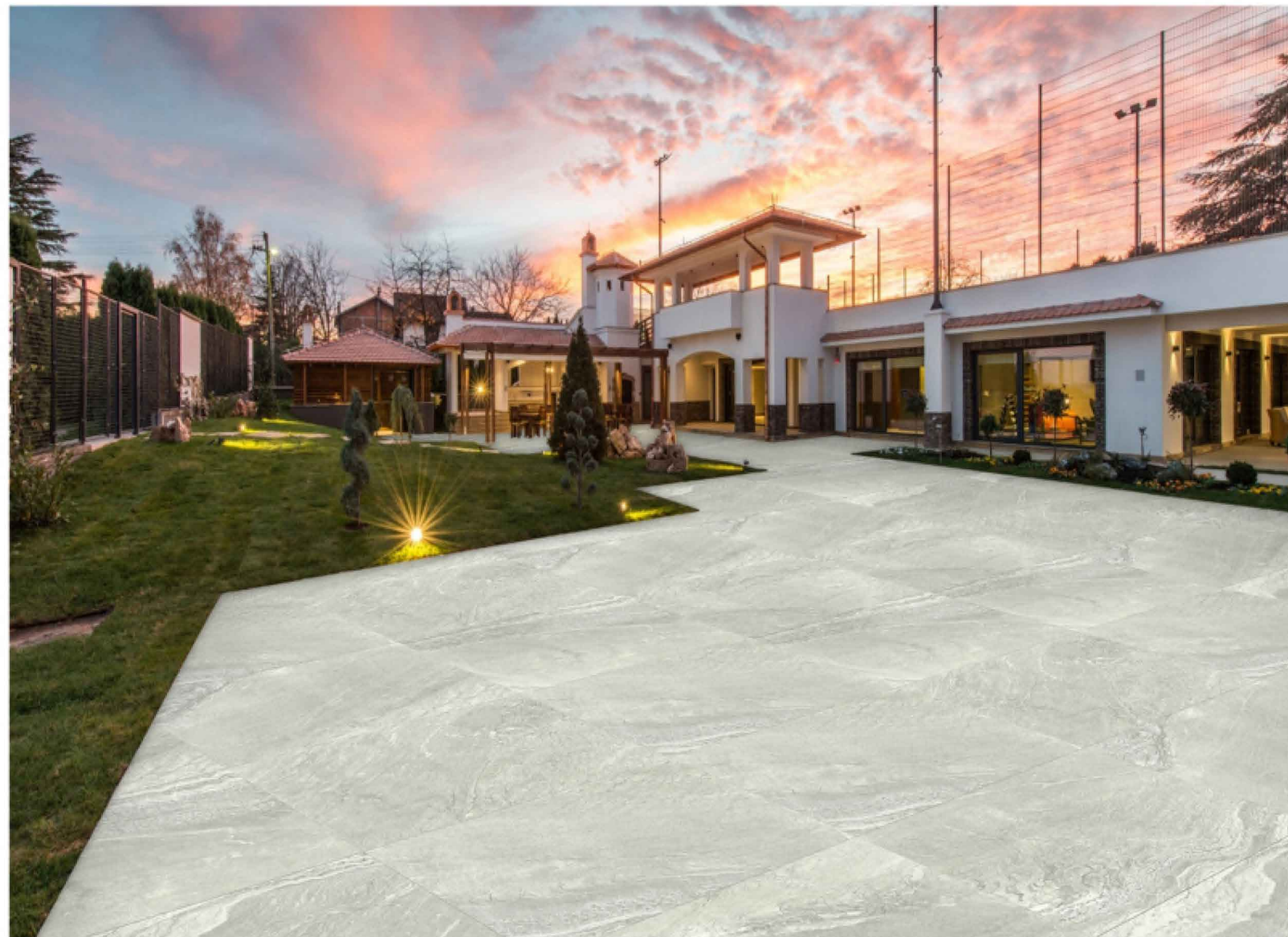

**20MM OUTDOOR  
PORCELAIN TILES**



NEWTON GREY-600X600 MM

20  
MM  
THICKNESS



**R11**

NOOR CREMA



600x1200 MM



600x900 MM



600x600 MM

800x800 MM

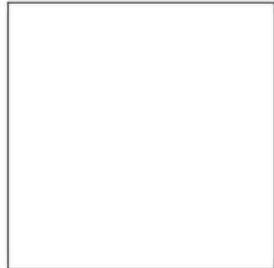

DIFFERENT SIZES

400x800 MM



COBBLES, BULLNOSE

300x600 MM

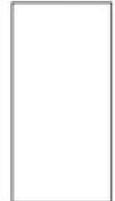

300x300 MM



100x200 MM

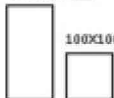

100x100 MM



800x1200 MM



200x1200 MM



300x900 MM



200x900 MM



STRIPS



**20MM OUTDOOR  
PORCELAIN TILES**



NOOR CREMA-600X1200 MM

20  
MM  
THICKNESS

**NOOR GREY**



600x1200 MM



600x900 MM

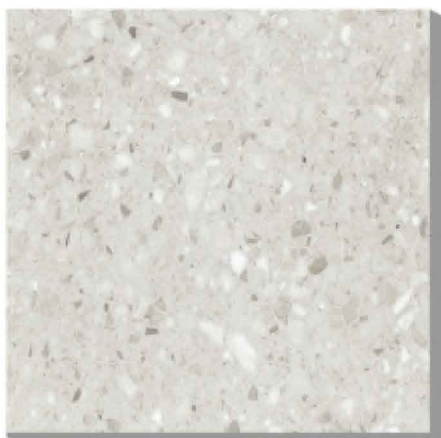

600x600 MM

800x800 MM

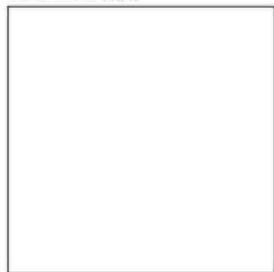

DIFFERENT SIZES

400x800 MM



COBBLES, BULLNOSE

300x600 MM



300x300 MM



100x200 MM

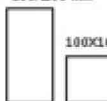

100x100 MM



300x1200 MM



200x1200 MM



300x900 MM



200x900 MM



STRIPS



**20MM OUTDOOR  
PORCELAIN TILES**



NOOR GREY-600X600 MM

20  
MM  
THICKNESS



OLYMPUS BEIGE



600x1200 MM



600x900 MM



600x600 MM

800x800 MM

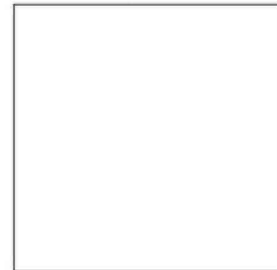

DIFFERENT SIZES

400x800 MM



COBBLES, BULLNOSE

300x600 MM



300x300 MM



100x200 MM

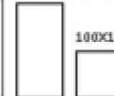

100x100 MM



800x1200 MM



200x1200 MM



300x900 MM



200x900 MM



STRIPS



R11



**20MM OUTDOOR  
PORCELAIN TILES**



OLYMPUS BEIGE-600X900 MM

20  
MM  
THICKNESS



**R11**

PACIFIC BROWN



600x1200 MM



600x900 MM



600x600 MM

800x800 MM

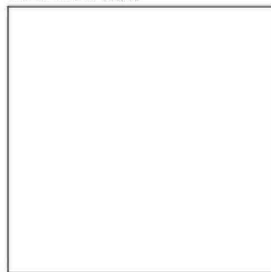

DIFFERENT SIZES

400x800 MM



COBBLES, BULLNOSE

300x600 MM



300x300 MM



100x200 MM



100x100 MM



800x1200 MM

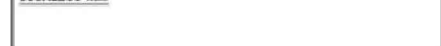

200x1200 MM



300x900 MM



200x900 MM



STRIPS



**20MM OUTDOOR  
PORCELAIN TILES**



PASIFIC BROWN-600X1200 MM

20  
MM  
THICKNESS

PERLATO CREMA



600x1200 MM

600x900 MM

600x600 MM

800x800 MM

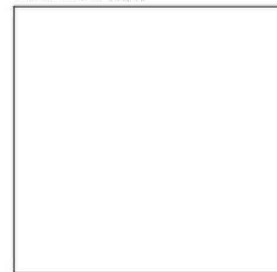

DIFFERENT SIZES

400x800 MM



COBBLES, BULLNOSE

300x600 MM



300x300 MM



100x200 MM

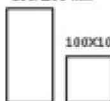

100x100 MM



300x1200 MM



200x1200 MM



300x900 MM



200x900 MM



STRIPS



**20MM OUTDOOR  
PORCELAIN TILES**

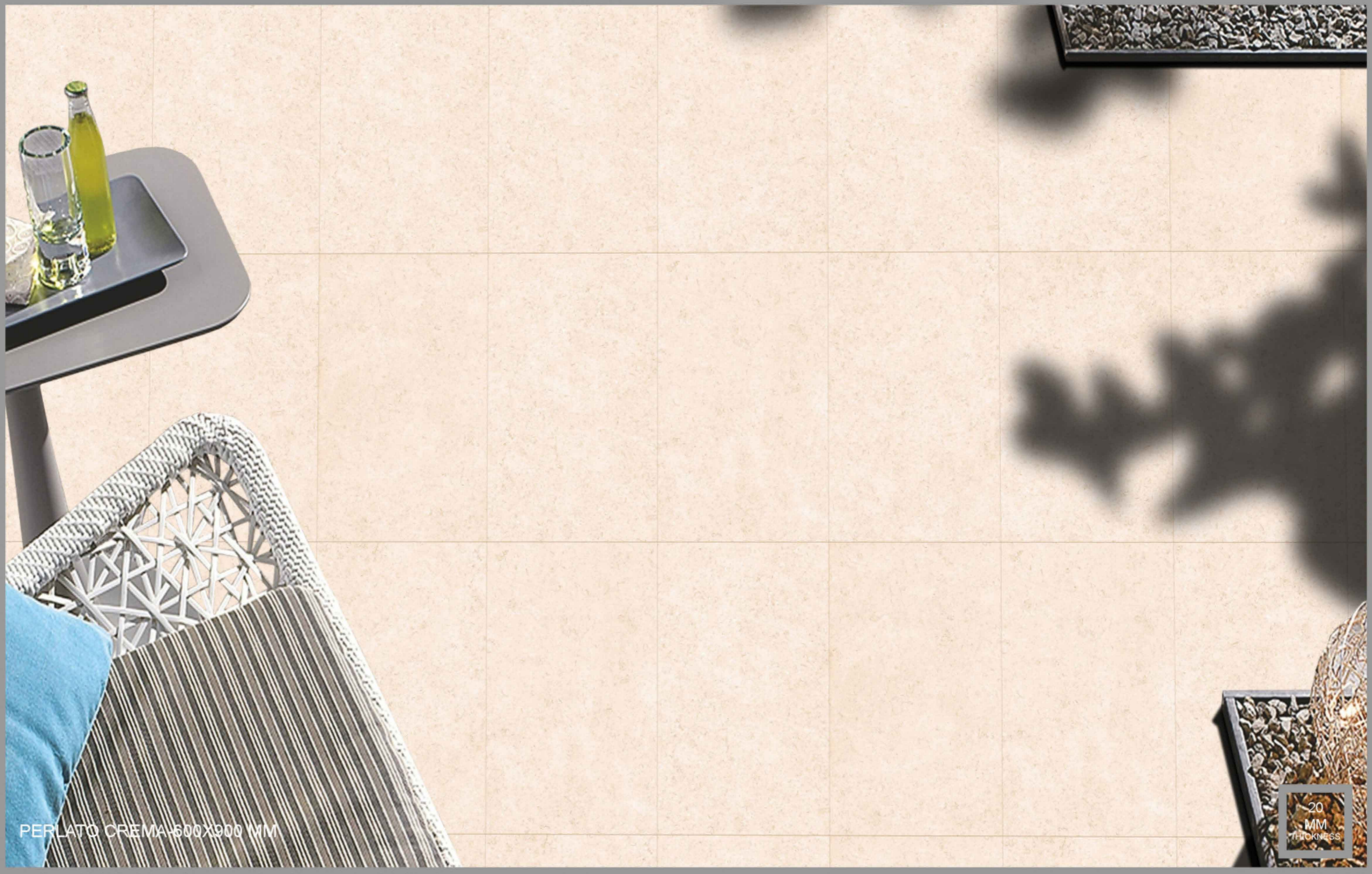

PERLATO CREMA 500X900 MM

20  
MM  
THICKNESS

PERLATO WHITE



600x1200 MM

600x900 MM

600x600 MM

800x800 MM

400x800 MM

300x600 MM

300x300 MM

100x200 MM

100x100 MM

300x1200 MM

200x1200 MM

300x900 MM

200x900 MM

DIFFERENT SIZES

COBBLES, BULLNOSE

STRIPS

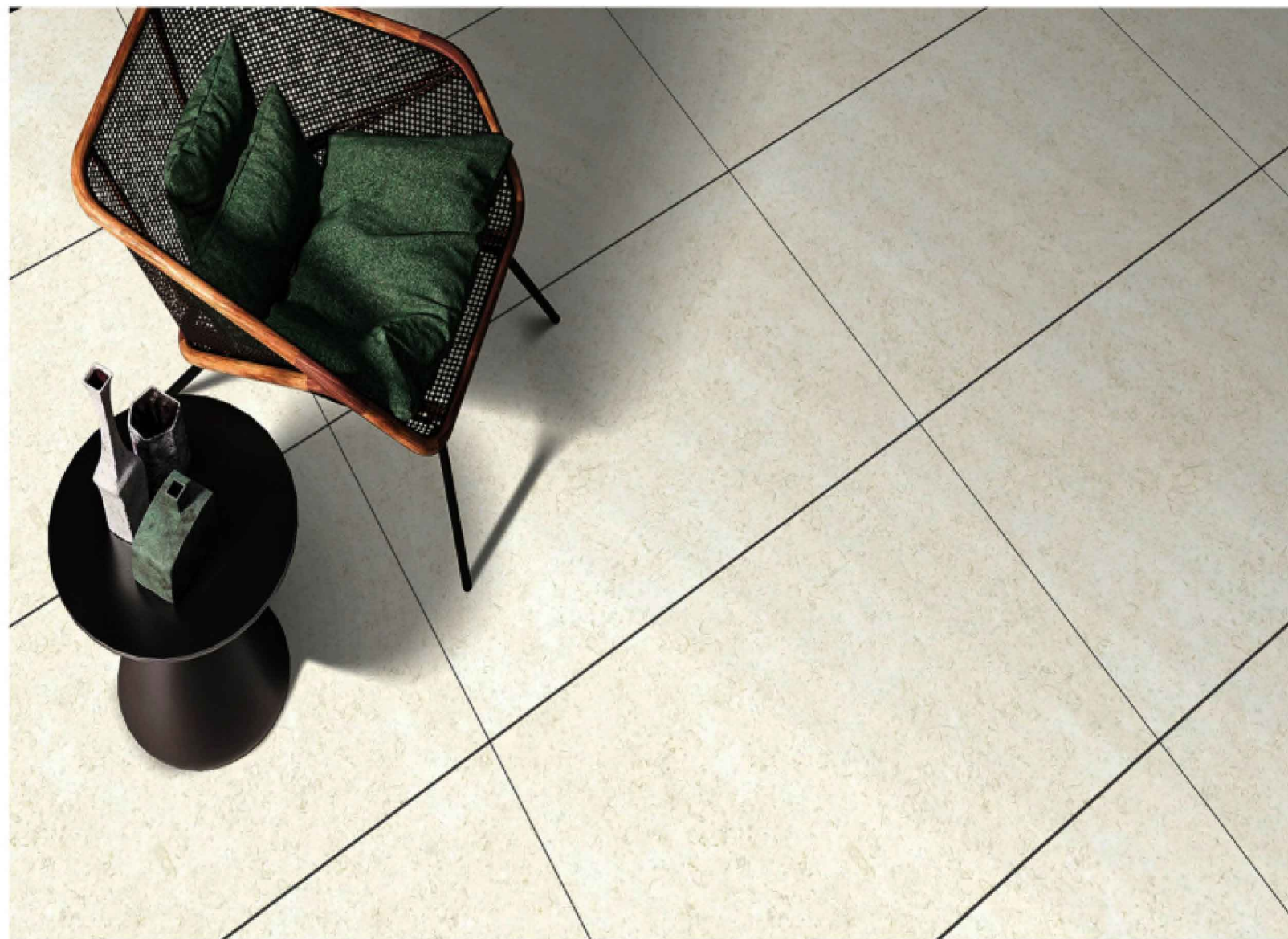

**20MM OUTDOOR**  
PORCELAIN TILES

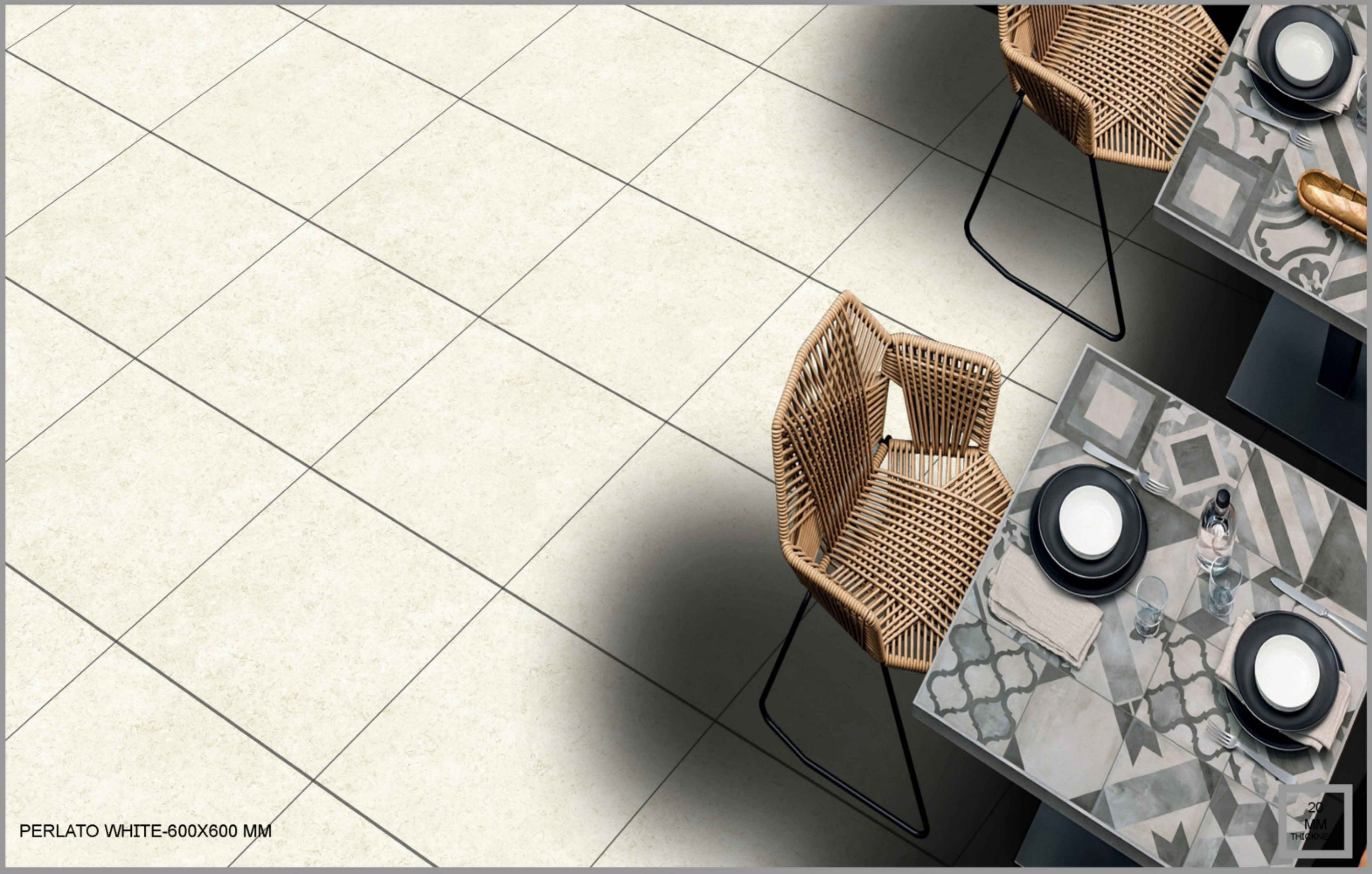

PERLATO WHITE-600X600 MM

20  
MM  
THICKNESS





**R11**

QUARTZ BLACK



600x1200 MM



600x900 MM



600x600 MM

800X800 MM

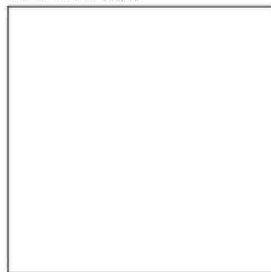

DIFFERENT SIZES

400X800 MM



COBBLES, BULLNOSE

300X600 MM

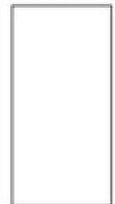

300X300 MM



100X200 MM

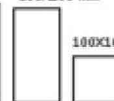

100X100 MM



800X1200 MM



200X1200 MM



300X900 MM



200X900 MM



STRIPS



**20MM OUTDOOR  
PORCELAIN TILES**

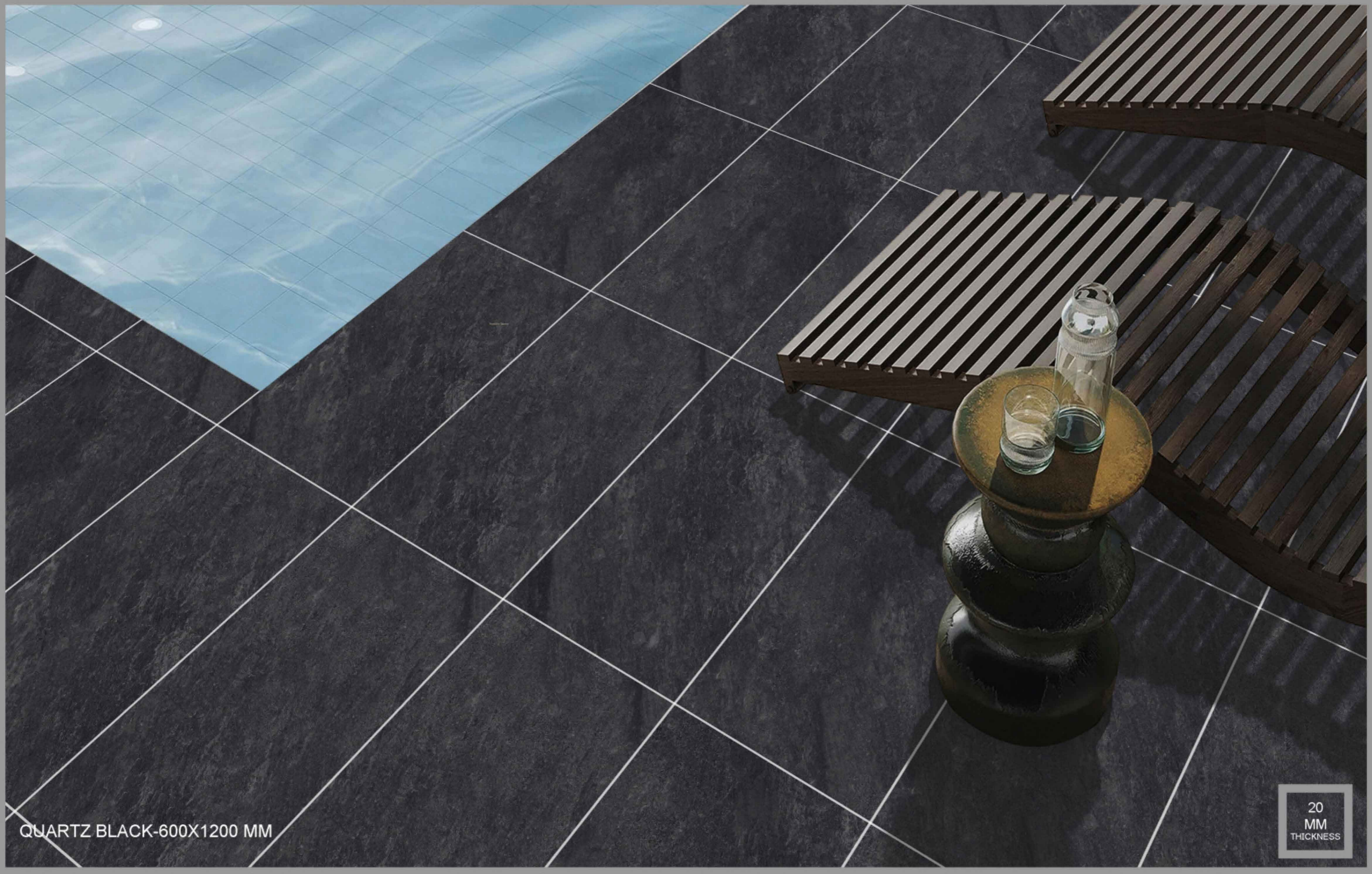

QUARTZ BLACK-600X1200 MM

20  
MM  
THICKNESS

R11

QUARTZ DARK GREY



600x1200 MM



600x900 MM



600x600 MM

800x800 MM

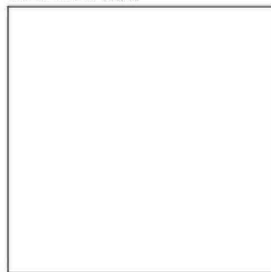

DIFFERENT SIZES

400x800 MM



COBBLES, BULLNOSE

300x600 MM



300x300 MM



100x200 MM



100x100 MM



300x1200 MM



200x1200 MM



300x900 MM



200x900 MM



STRIPS

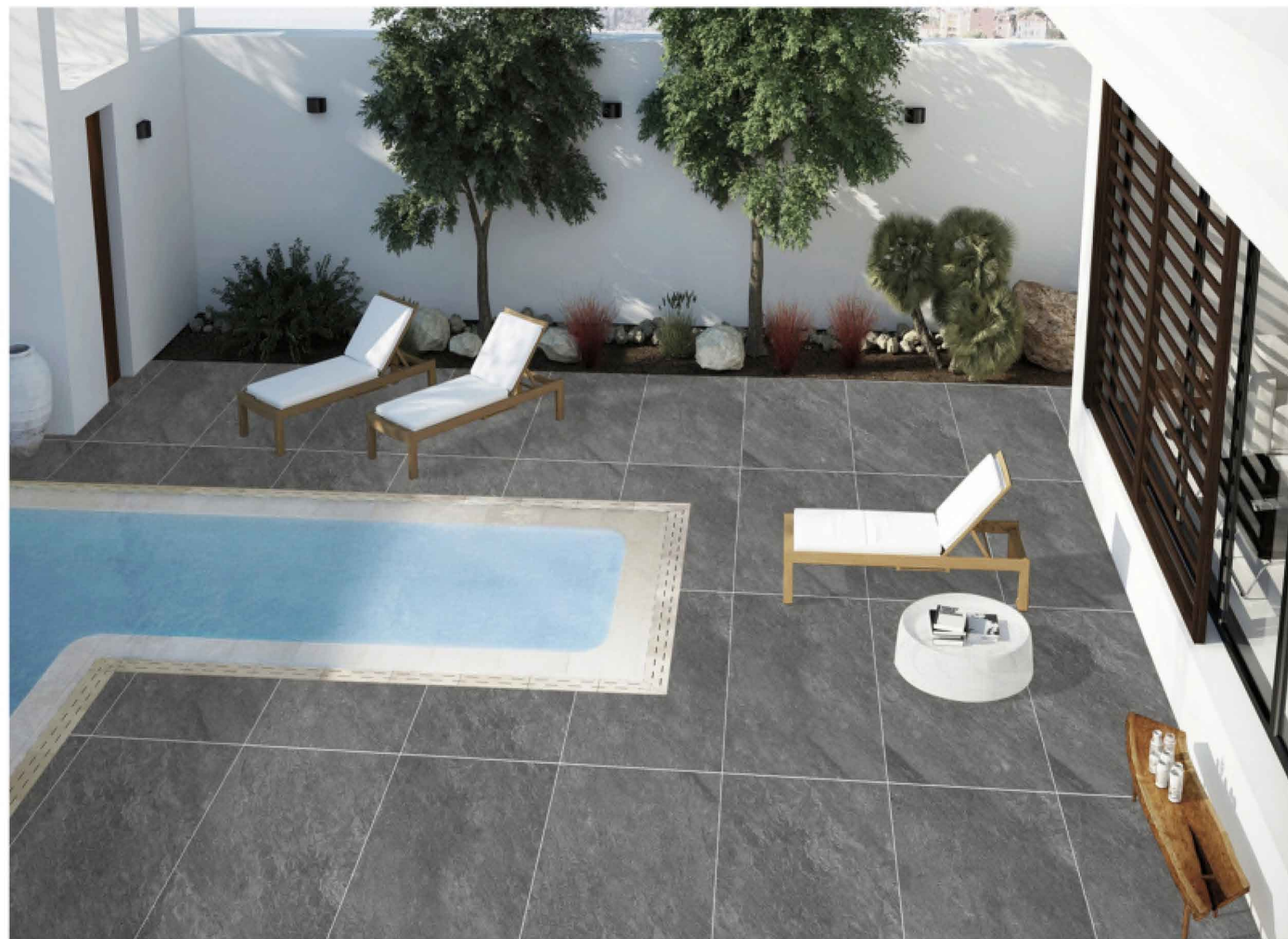

**20MM OUTDOOR  
PORCELAIN TILES**



QUARTZ DARK GREY-600X1200 MM

20  
MM  
THICKNESS



**R11**

QUARTZ GREY



600x1200 MM

600x900 MM

600x600 MM

800x800 MM

400x800 MM

300x600 MM

300x300 MM

100x200 MM

100x100 MM

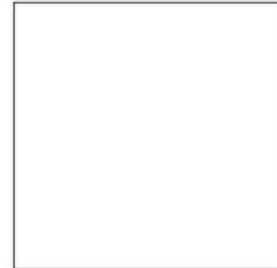

DIFFERENT SIZES



COBBLES, BULLNOSE

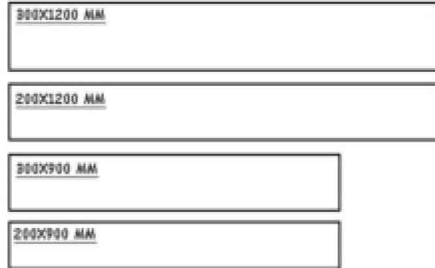

STRIPS



**20MM OUTDOOR  
PORCELAIN TILES**



QUARTZ GREY-600X600 MM

20  
MM  
THICKNESS



**R11**

QUARTZ WHITE



600x1200 MM

600x900 MM

600x600 MM



800x800 MM

400x800 MM

300x600 MM

300x300 MM

100x200 MM

100x100 MM



DIFFERENT SIZES



COBBLES, BULLNOSE

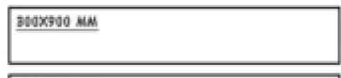
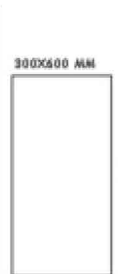

STRIPS



**20MM OUTDOOR  
PORCELAIN TILES**



QUARTZ GREY-600X900 MM

20  
MM  
THICKNESS





**R11**

**RAJ GREEN**



600x1200 MM



600x900 MM



600x600 MM

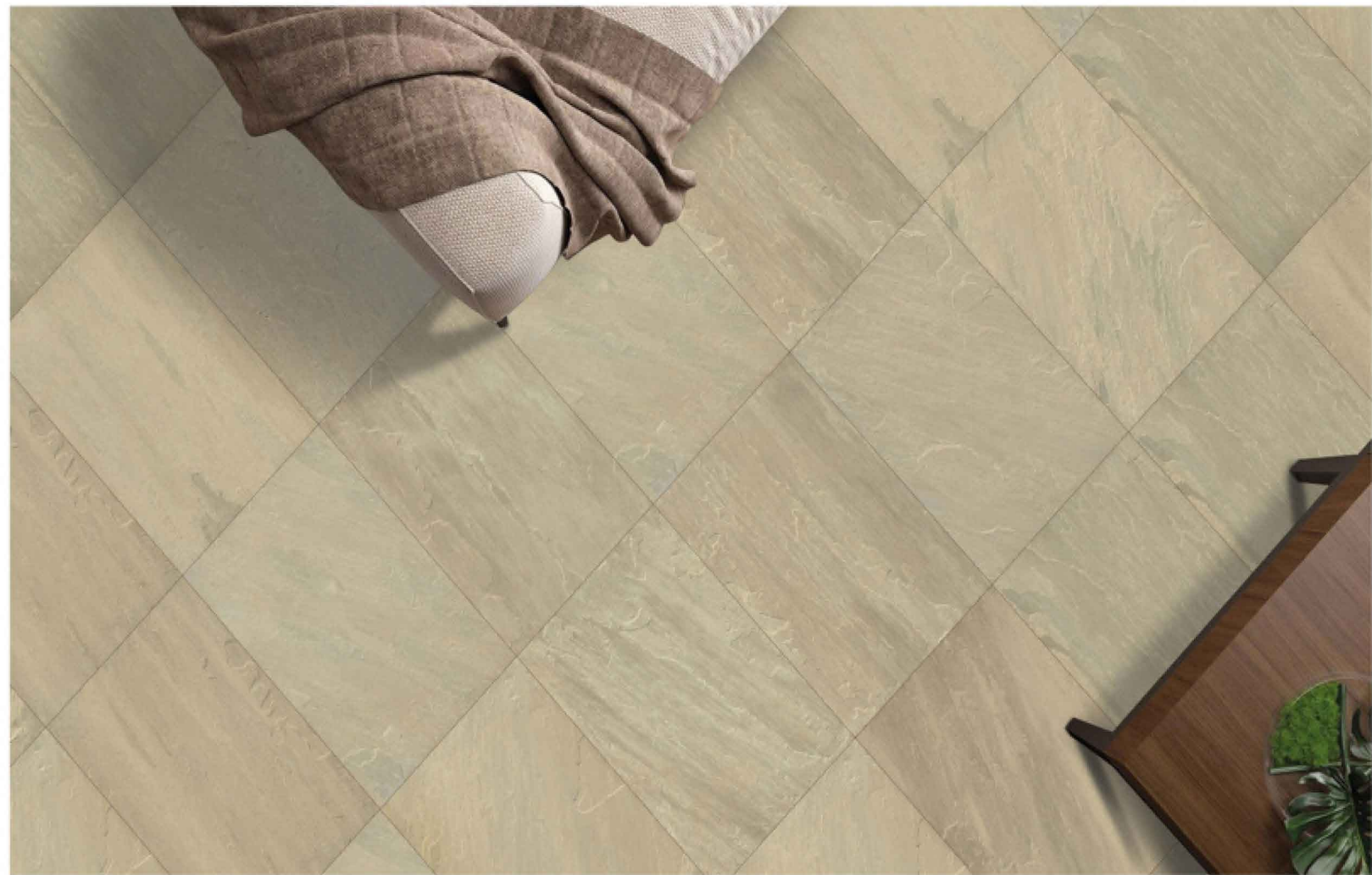

800X800 MM

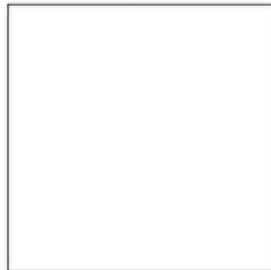

DIFFERENT SIZES

400X800 MM



COBBLES, BULLNOSE

300X600 MM

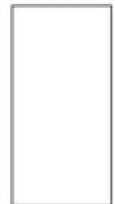

300X300 MM



100X200 MM



100X100 MM



300X1200 MM



200X1200 MM



300X900 MM



200X900 MM



STRIPS



**20MM OUTDOOR  
PORCELAIN TILES**



RAJ GREEN-600X900 MM



ROUGH BRUNO



600x1200 MM



600x900 MM



600x600 MM

800x800 MM

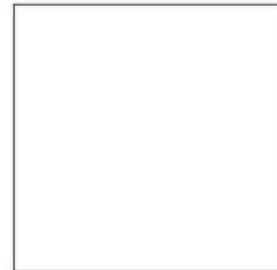

DIFFERENT SIZES

400x800 MM



COBBLES, BULLNOSE

300x600 MM



300x300 MM



100x200 MM

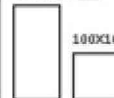

100x100 MM



300x1200 MM



200x1200 MM



300x900 MM



200x900 MM



STRIPS



R11



**20MM OUTDOOR  
PORCELAIN TILES**



ROUGH BRUNO-600X1200 MM

20  
MM  
THICKNESS



R11

SEA SAND BEIGE



600x1200 MM

600x900 MM

600x600 MM

800x800 MM

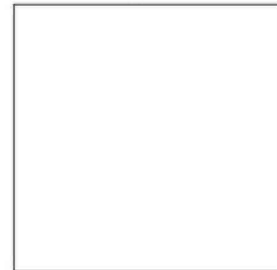

DIFFERENT SIZES

400x800 MM



COBBLES, BULLNOSE

300x600 MM



300x300 MM



100x200 MM



100x100 MM



300x1200 MM



200x1200 MM



300x900 MM



200x900 MM



STRIPS



**20MM OUTDOOR  
PORCELAIN TILES**



SEA SAND BEIGE-600X900 MM

20  
MM  
THICKNESS



**R11**

SEA SAND GREY



600x1200 MM



600x900 MM



600x600 MM

800x800 MM

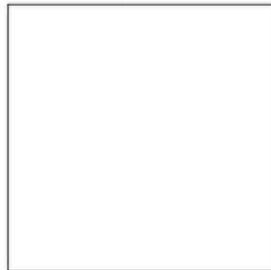

DIFFERENT SIZES

400x800 MM



COBBLES, BULLNOSE

300x600 MM



300x300 MM



100x200 MM

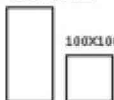

100x100 MM



300x1200 MM



200x1200 MM



300x900 MM



200x900 MM



STRIPS



**20MM OUTDOOR  
PORCELAIN TILES**





SEA SAND GREY-600X600 MM

20  
MM  
THICKNESS





**R11**

SEA SAND NERO



600x1200 MM



600x900 MM



600x600 MM

800x800 MM

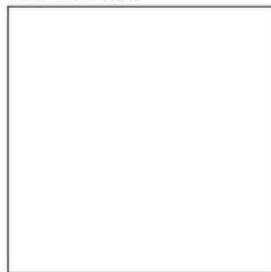

DIFFERENT SIZES

400x800 MM



COBBLES, BULLNOSE

300x600 MM



300x300 MM



100x200 MM



100x100 MM



300x1200 MM



200x1200 MM



300x900 MM



200x900 MM



STRIPS



**20MM OUTDOOR  
PORCELAIN TILES**



SEA SAND NERO-600X900 MM

20  
MM  
THICKNESS



**R11**

**SILVER GRANITE**



600x1200 MM

600x900 MM

600x600 MM

800x800 MM

400x800 MM

300x600 MM

300x300 MM

100x200 MM

100x100 MM

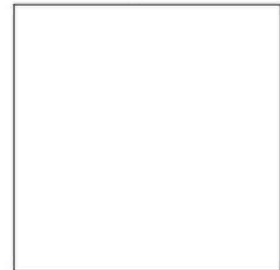

DIFFERENT SIZES



COBBLES, BULLNOSE

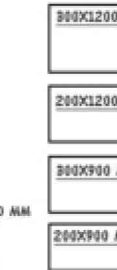
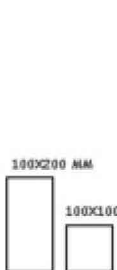
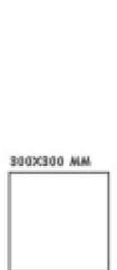

STRIPS



20 MM THICKNESS



**20MM OUTDOOR  
PORCELAIN TILES**



SILVER GRANITE-600X900 MM

20  
MM  
THICKNESS

SPIRIT GREY



600x1200 MM

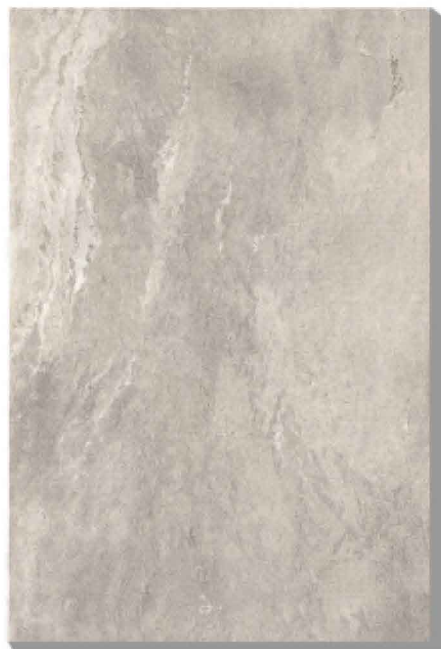

600x900 MM



600x600 MM

800X800 MM

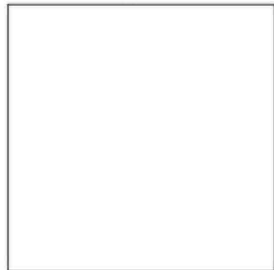

DIFFERENT SIZES

400X800 MM



COBBLES, BULLNOSE

300X600 MM



300X300 MM



100X200 MM



100X100 MM



300X1200 MM



200X1200 MM



300X900 MM



200X900 MM



STRIPS



**20MM OUTDOOR  
PORCELAIN TILES**



SPIRIT GREY-600X600 MM

20  
MM  
THICKNESS

STATURIO



600x1200 MM

600x900 MM

600x600 MM

800x800 MM

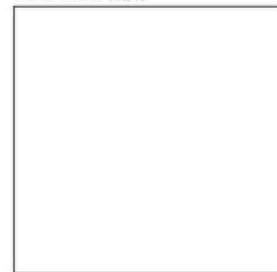

DIFFERENT SIZES

400x800 MM



COBBLES, BULLNOSE

300x600 MM



300x300 MM



100x200 MM

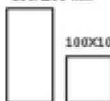

100x100 MM



800x1200 MM



200x1200 MM



300x900 MM



200x900 MM



STRIPS

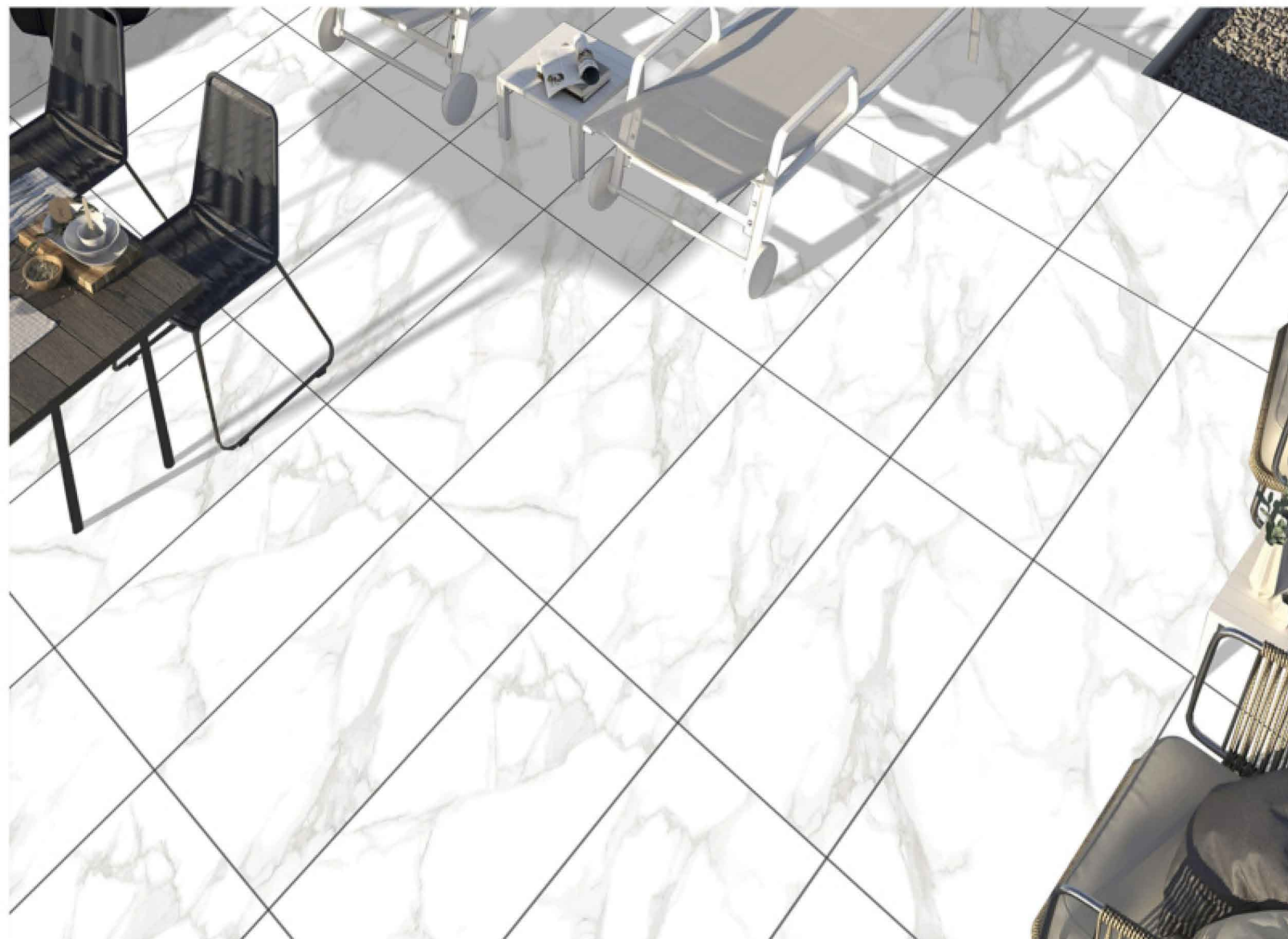

**20MM OUTDOOR  
PORCELAIN TILES**



SPRINT 600x900

20  
MM  
THICKNESS



# TEAK STONE CONCRETE



600x1200 MM



600x900 MM



600x600 MM



DIFFERENT SIZES

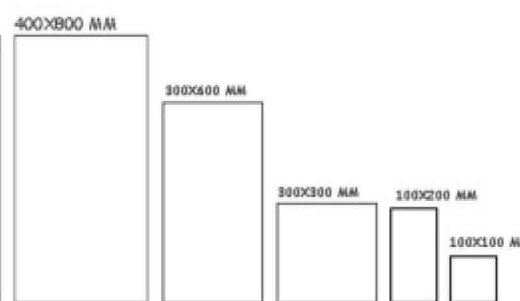

COBBLES, BULLNOSE

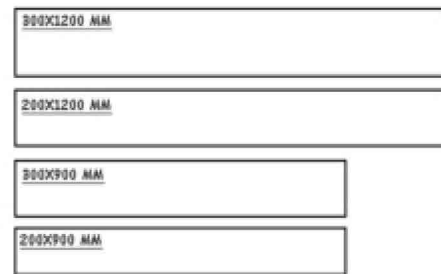

STRIPS



R11



**20MM OUTDOOR  
PORCELAIN TILES**



TEAK STONE CONCRETE-600X900 MM

20  
MM  
THICKNESS



**R11**

TEAK STONE LIGHT GREY



600x1200 MM



600x900 MM



600x600 MM



DIFFERENT SIZES

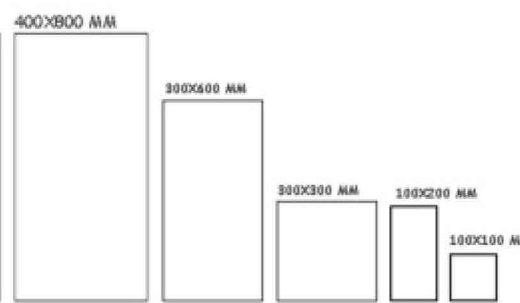

COBBLES, BULLNOSE

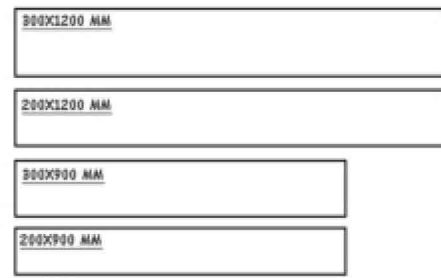

STRIPS



**20MM OUTDOOR  
PORCELAIN TILES**



TEAK STONE LIGHT GREY 600X600 MM

20  
MM  
THICKNESS



**R11**

TRAVERTINE BEIGE



600x1200 MM



600x900 MM



600x600 MM

800x800 MM

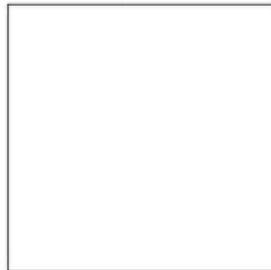

DIFFERENT SIZES

400x800 MM



COBBLES, BULLNOSE

300x600 MM



300x300 MM



100x200 MM

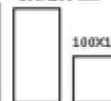

100x100 MM



300x1200 MM



200x1200 MM



300x900 MM



200x900 MM



STRIPS



**20MM OUTDOOR  
PORCELAIN TILES**



TRAVERTINE BEIGE-600X900 MM

20  
MM  
THICKNESS

TRAVERTINE GRIS



600x1200 MM

600x900 MM

600x600 MM

800x800 MM

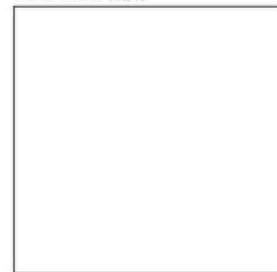

DIFFERENT SIZES

400x800 MM



COBBLES, BULLNOSE

300x600 MM



300x300 MM



100x200 MM

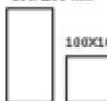

100x100 MM



800x1200 MM



200x1200 MM



300x900 MM



200x900 MM



STRIPS



**20MM OUTDOOR  
PORCELAIN TILES**



TRAVERTINE GRIS-600X600 MM

20  
MM  
THICKNESS



TUSCAN ANTHRACITE



600x1200 MM



600x900 MM



600x600 MM

800X800 MM

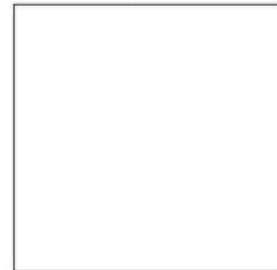

DIFFERENT SIZES

400X800 MM



COBBLES, BULLNOSE

300X600 MM



300X300 MM



100X200 MM

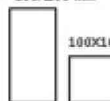

100X100 MM



300X1200 MM



200X1200 MM



300X900 MM



200X900 MM



STRIPS



**20MM OUTDOOR  
PORCELAIN TILES**



TUSCAN ANTHRACITE 600X900 MM

20  
MM  
THICKNESS

OAK WOOD ASH



600x1200 MM

300x1200 MM

200x1200 MM 600x600 MM

800x800 MM

400x800 MM

300x600 MM

300x300 MM

100x200 MM

100x100 MM

300x1200 MM

200x1200 MM

300x900 MM

200x900 MM

DIFFERENT SIZES

COBBLES, BULLNOSE

STRIPS



**20MM OUTDOOR**  
**PORCELAIN TILES**



OAK WOOD ASH-600X1200 MM

20  
MM  
THICKNESS

  
**R11**

OAK WOOD BROWN



600x1200 MM      300x1200 MM      200x1200 MM      600x600 MM

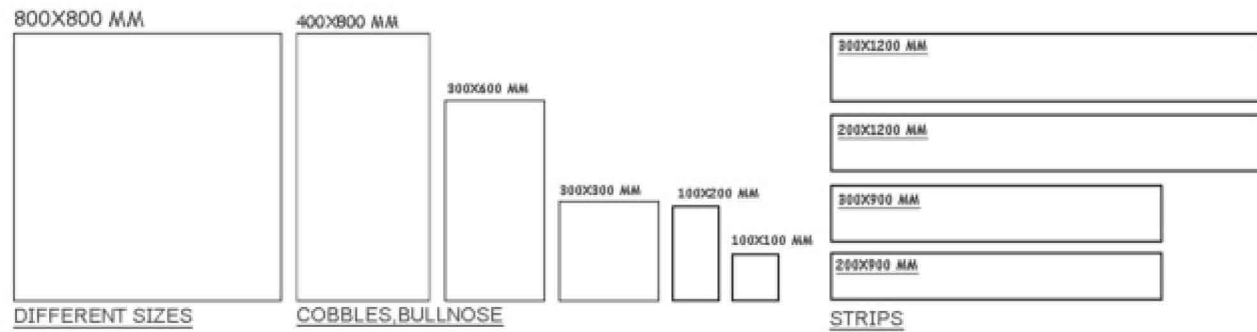

**20 MM THICKNESS**

**20MM OUTDOOR PORCELAIN TILES**

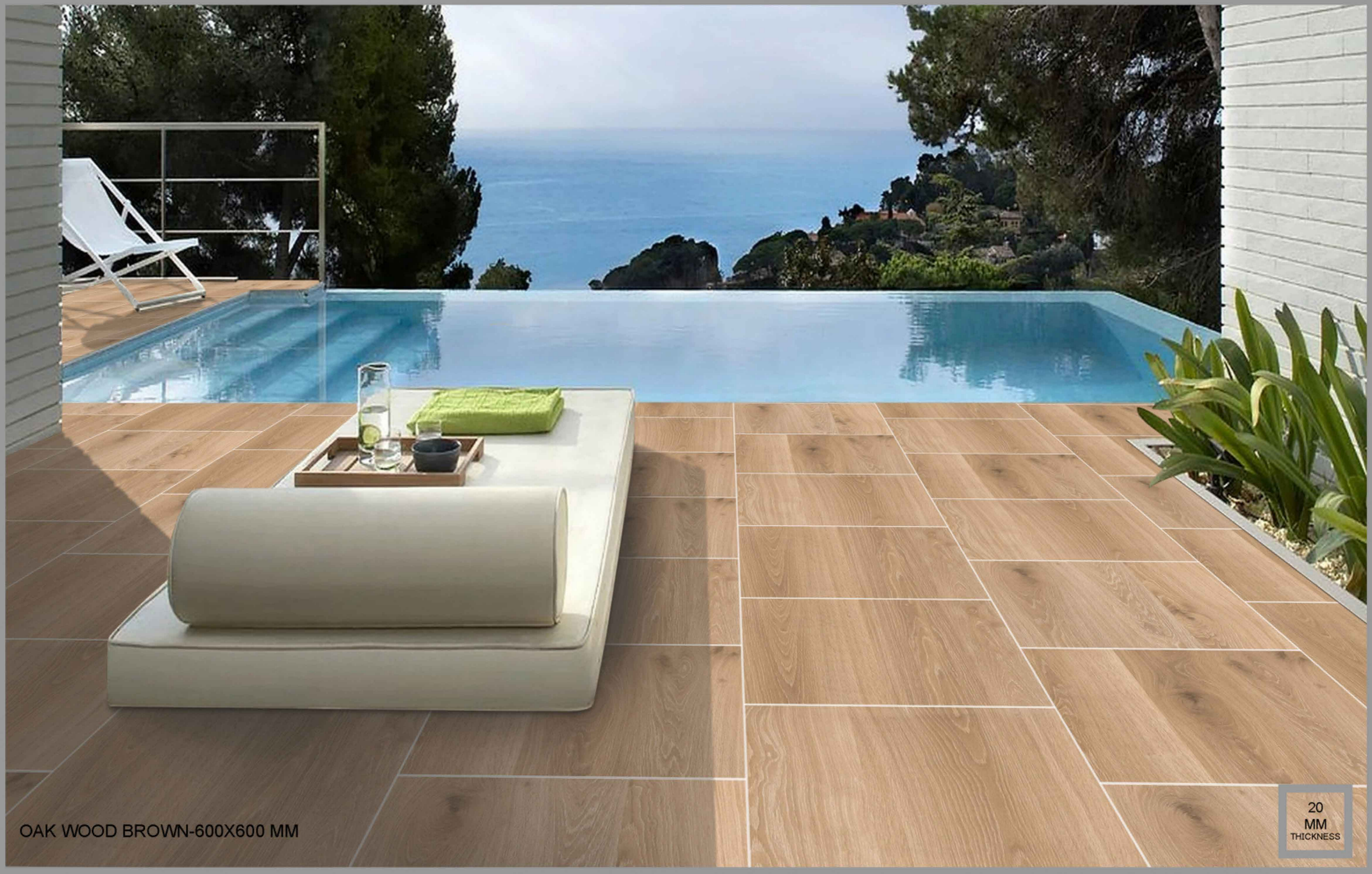

OAK WOOD BROWN-600X600 MM

20  
MM  
THICKNESS

OAK WOOD GREY



600x1200 MM

300x1200 MM

200x1200 MM

600x600 MM

800x800 MM

400x800 MM

300x600 MM

300x300 MM

100x200 MM

100x100 MM

800x1200 MM

200x1200 MM

300x900 MM

200x900 MM

DIFFERENT SIZES

COBBLES, BULLNOSE

STRIPS



**20MM OUTDOOR  
PORCELAIN TILES**



PB&I  
BLACK IRON OXIDE

OAK WOOD GREY-600X1200 MM

20  
MM  
THICKNESS





**R11**

WHITE WOOD



600x1200 MM      300x1200 MM      200x1200 MM      600x600 MM

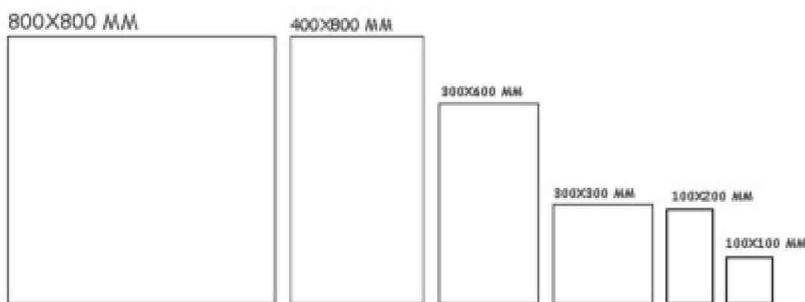

DIFFERENT SIZES      COBBLES, BULLNOSE

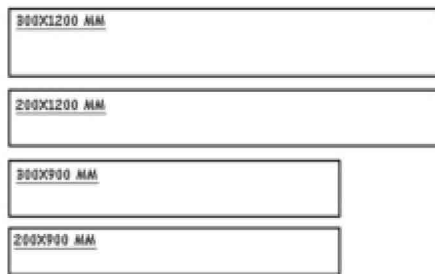

STRIPS

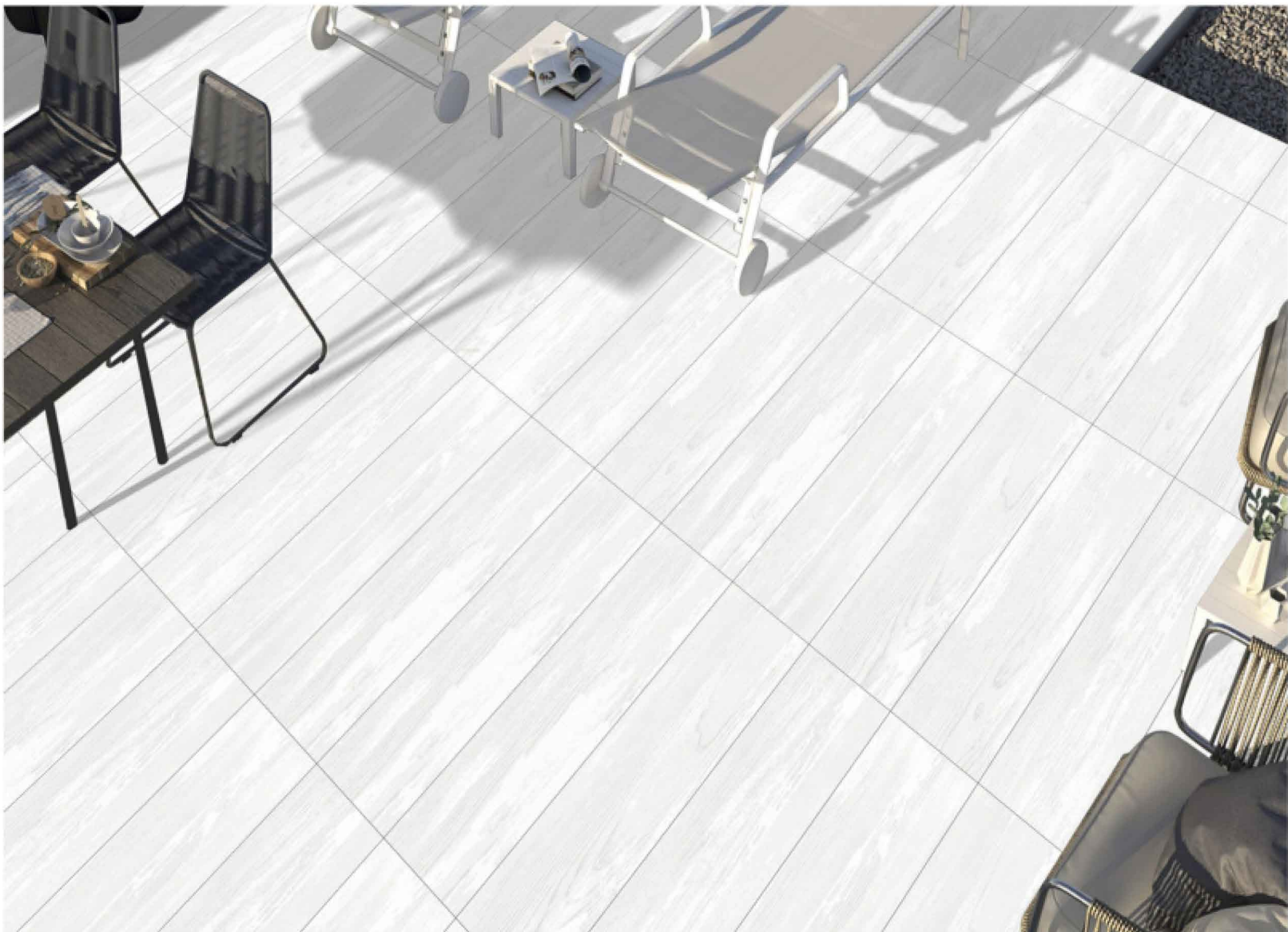

**20MM OUTDOOR  
PORCELAIN TILES**

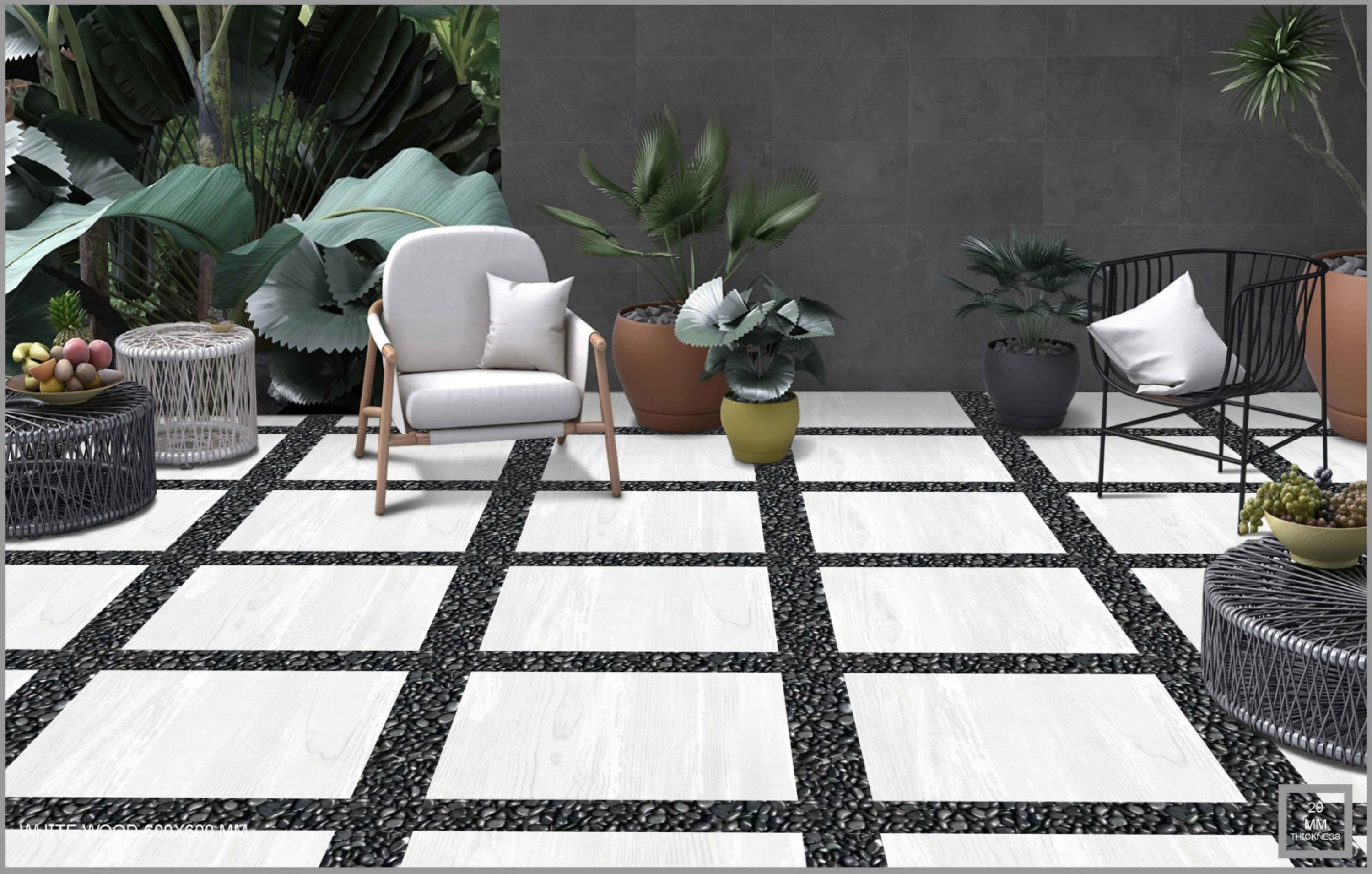

WHITE WOOD 600X600 MM

20  
MM  
THICKNESS

## PORCELAIN STONEWARE TILE 20MM FOR OUTDOOR FLOORING

20mm outdoor porcelain stoneware is the product with the highest technical performance, ideal for flooring in an outdoor environment without the risk of breakage and without interrupting the continuity between interior and exterior spaces. Resistant to frost and thermal

shock, it has intensified anti-slip characteristics and is easy to clean. The perfect union between high technical performance and aesthetics helps maintain the material and color unchanged over time, guaranteeing long-lasting durability.

### VERSATILE



EASY TO LAY,  
REMOVE AND REUSE



COLORS REMAIN  
STABLE OVER TIME



CAN BE INSTALLED WITH DIFFERENT LAYING SYSTEMS



MULTIPLE AESTHETIC  
VARIATIONS SEAMLESSLY  
COMBINE OUTDOOR AND  
INDOOR FLOORING



ATTENTION TO DETAIL  
AND SPECIAL PIECES FOR  
AESTHETIC RESULTS THAT  
MAKE A GREAT IMPACT



### RESISTANT



FROST-RESISTANT



FIRE-PROOF



RESISTANT TO STAINS,  
ACIDS AND CHEMICAL AGENTS



RESISTANT TO SALT



RESISTANT  
TO MOULD AND BACTERIA



HIGHLY RESISTANT  
TO HEAVY LOADS



HIGH RESISTANCE  
TO THERMAL SHOCK

### FUNCTIONAL



NON-SLIP SURFACES



RESISTANT TO VEHICULAR  
PASSAGE IF APPLIED TO A  
SCREED



ECO-FRIENDLY



LEED COMPLIANT

### ECO-FRIENDLY



EASY TO CLEAN

## INTENDED USES

Owing to the possibility of installing it dry (on grass, sand, gravel, and elevated floors) the 20mm porcelain outdoor tile collection is the

most versatile solution for exterior floors in residential and public areas.

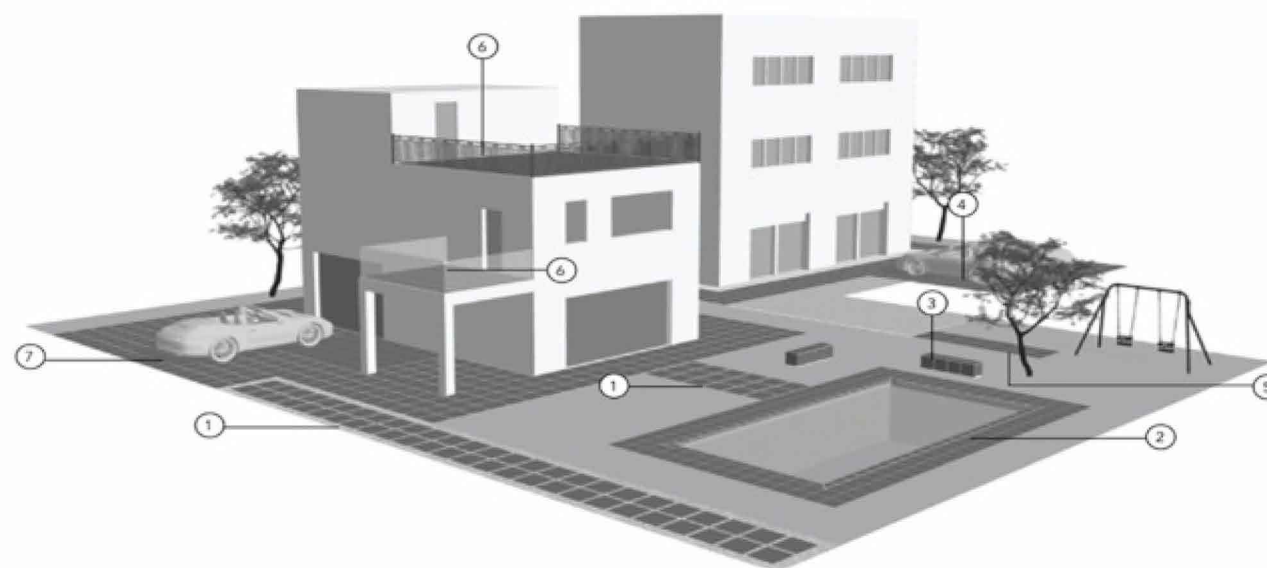

1 DRIVEWAYS AND  
PATHWAYS

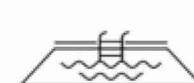

2 SWIMMING POOLS, SPAS  
AND ADJOINING AREAS



3 URBAN FURNITURE  
AND PUBLIC PLACES



4 HIGH-TRAFFIC  
INDUSTRIAL ZONES



5 PUBLIC PARKS  
AND GARDENS



6 TERRACES AND  
BALCONIES



7 CAR PARKS  
AND DRIVEWAY AREAS



OTHER APPLICATION  
SOLUTIONS

## LAYING SOLUTIONS

Outdoor porcelain 20mm tiles are an innovative solution that is very versatile due to the numerous laying possibilities they offer: dry

### DRY INSTALLATION ON GRASS

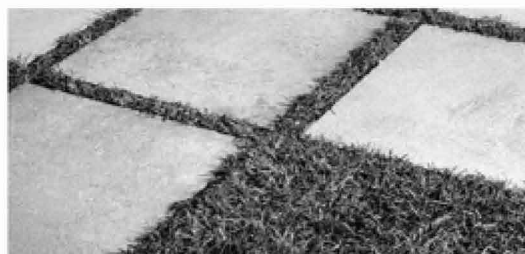

a. Easy to lay, adjust, and move. An ideal solution for public parks and private gardens.



### DRY INSTALLATION ON GRAVEL / SAND



b. Easy to lay, adjust, and move. Boasts ideal aesthetic features to enhance contemporary buildings.



### INSTALLATION ON SCREED WITH ADHESIVE



c. Build resilient and durable outdoor spaces, pathways, driveways, and more with the installation of 20mm tiles on screed with adhesive.



### ELEVATED FLOOR INSTALLATION



d. Easily removable, inspectable, and reusable. Ideal to be applied with different kinds of support and is apt for concealing wiring pipes, and more with accessibility.

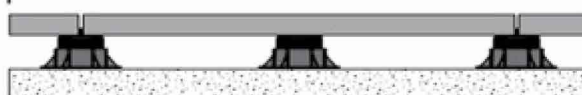

#### CAUTION

- When carrying out an elevated floor installation it is recommended to check the intended use and to follow the installation instructions.
- In the case of external dry installation, the force of the wind, in particular types of applications or geographical locations, can cause the lifting of the tiles. It is recommended that the designer/client always check the suitability of the installation system selected according to local regulations in force.
- Failure to follow the above recommendations may result in misuse of the product and cause injury to persons and/or damage to property.

## DRY INSTALLATION ON GRASS

To create a pathway with stepping stones, first of all, it is important to determine the number of steps necessary for the entire path, making sure that the tiles are positioned equidistantly. So as to obtain maximum stability, it is recommended to

dig out about 5/8cm from the soil, and then place a fine layer of gravel. Compact the substrate and then position the tile. To allow the turf to grow well, it is advisable to leave a gap of at least 10cm between one tile and another.



SAFE AND STABLE



LONG-LASTING



EASY TO CLEAN



DRAINS

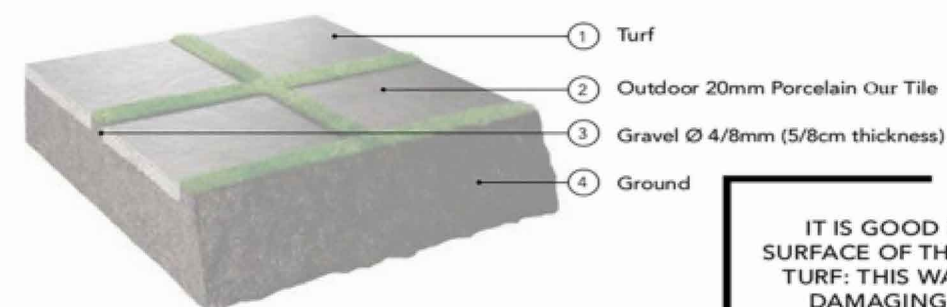

IT IS GOOD PRACTICE TO LAY THE SURFACE OF THE TILES IN LINE WITH THE TURF: THIS WAY THERE IS NO RISK OF DAMAGING THE LAWN MOWERS.

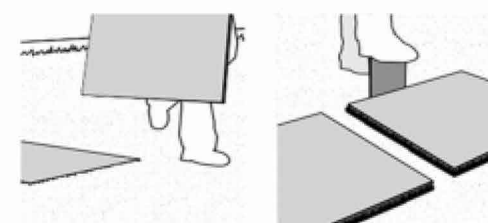

1/2

To determine the correct sizing and positioning of the flooring, place the tiles on the ground and carefully position them equidistant from each other. Mark the perimeter of the tile using a spade in the soil.

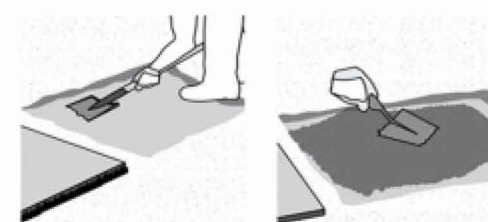

3/4

Remove the turf and dig out about 5cm of soil. Form a stable and uniform substrate using fine gravel (grain size 4/8mm).

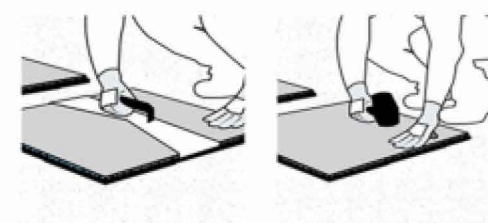

5/6

Lay the tile, so as to have an approximately 0.5cm level difference, between the tile and the ground. To simplify tile installation it is possible to use suitable tile installation handles. Knock the tile along the edges with a rubber hammer until it is at the same level as the turf.

#### CAUTION

The application layers proposed are to be taken as an indication, and have the sole purpose of showing how to obtain a correct flooring.

## DRY INSTALLATION ON GRAVEL / SAND

For installation on sand it is good to remember to place a geotextile on the gravel, on which to spread out a layer (from 2 to 5cm thick) of dry sand with a grain size of 0/2mm. It is necessary to compact the sand with a vibro-compacting plate

before proceeding with the installation of the tiles. For particular uses and for stressful loads, it is advisable to consult a technician in order to calculate precisely the thicknesses of the various layers of the substrate.



SAFE AND STABLE



LONG-LASTING



EASY TO CLEAN



DRAINS

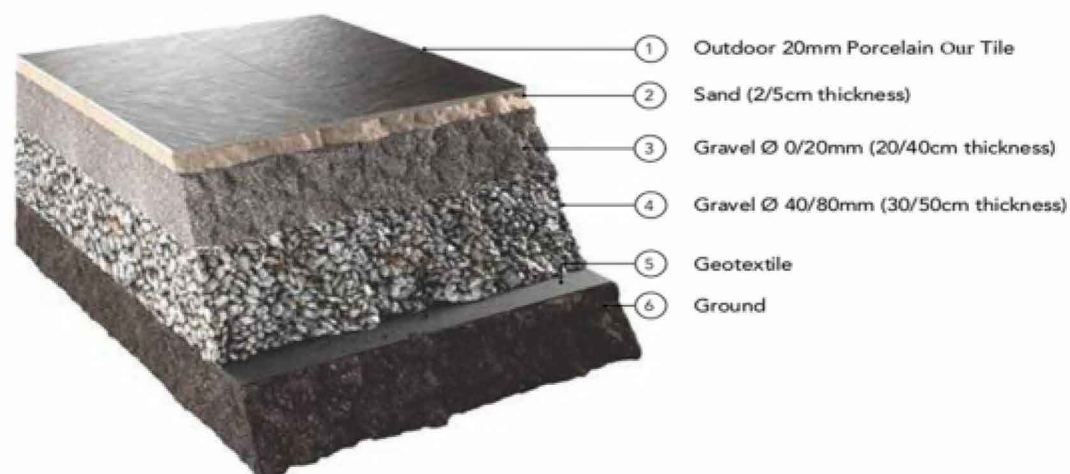

### CAUTION

The application layers proposed are to be taken as an indication, and have the sole purpose of showing how to obtain a correct flooring. It is recommended to always refer to the specific norms and regulations in each individual country and the instructions of the project supervisor.

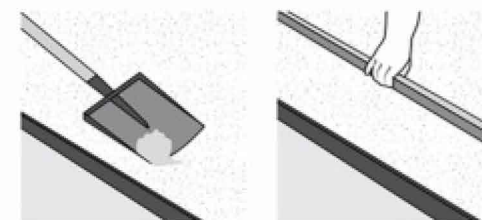

1/2

Form a stable and uniform substrate using fine gravel or sand. Level the substrate with a metal straight edge.

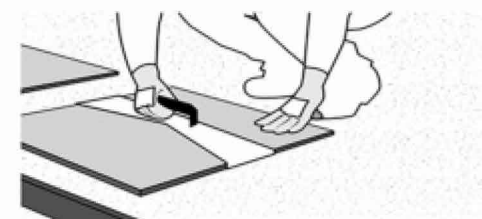

3

Position the tile and then compact the edges in order to level the tile with the substrate. It is suggested to use a joint of at least 4mm to allow good water drainage.

  
**IN ORDER TO AVOID THE DISPLACEMENT OF THE SUBSTRATE AND CONSEQUENTLY THE TILES, THE SUBSTRATE MUST BE PARTITIONED WITH CONTAINMENT EDGES OR PERIMETER CURBS.**

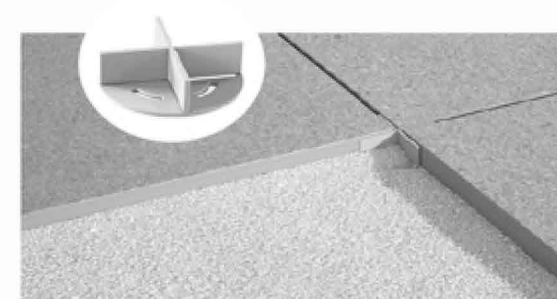

Spacers designed for laying tiles on sand or gravel are an extremely versatile and practical system despite their simplicity. The support is made up of a head with a spacer cross and a removable tip: the fins of the head cross help position the tiles and create the joint between them, ensuring that over time the flooring maintains its correct positioning. The tip is specific for application on sand: the elongated shape guarantees the anchorage and stability of the tiles, preventing them from slipping. For use on gravel, it is possible to remove the tip and place the spacer head directly on the gravel.

## INSTALLATION ON SCREED WITH ADHESIVE

For installation on screed with adhesive we recommend a joint of at least 5mm. The size and position of the expansion joints must be established by the project supervisor; they must have an indicative width ranging from 4 to 12mm and divide the surface to be paved in a uniform

pattern with dimensions ranging from approximately 3x3m to 4x2.5m. To facilitate the flow of rainwater, it is always necessary to assess the slopes of outdoor paving; when laying with adhesives on screed, the slopes are determined by the latter.



SAFE AND STABLE



LONG-LASTING



EASY TO CLEAN



RESISTANT TO VEHICULAR  
PASSAGE



- ① Grout min CG2W (EN 13888)
- ② Outdoor 20mm Porcelain Our Tile
- ③ Adhesive for exteriors min C2ES1 (EN 12004)
- ④ Possible waterproofing layer (2/4mm thick)
- ⑤ Sloping screed (5/10cm thick - slope >1.5%)
- ⑥ Concrete reinforced with electro-welded mesh (10/25cm thick)
- ⑦ Ground

  
**IN ORDER TO AVOID AESTHETICALLY UNPLEASANT CUTS OF THE TILES, IT IS SUGGESTED TO DEFINE THE SLOPES OF THE SCREED TAKING INTO ACCOUNT THE SIZE CHOSEN FOR THE INSTALLATION.**

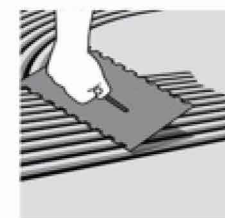
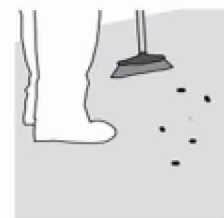

1/2

Before proceeding with the installation clean the substrate thoroughly. In order to obtain a flat floor, it is important to apply an even layer of adhesive.

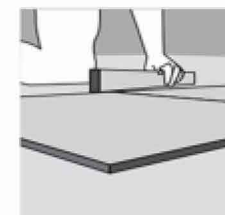
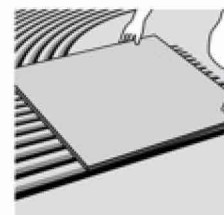

3/4

Check the planarity of the flooring regularly during the laying operations.



5/6

Once the installation is finished grout the flooring. Remember to observe the times indicated by the manufacturer for light foot traffic before walking on the tiles. "Post-installation" cleaning is mandatory at the end of the work and is required to remove residues of cement, lime or grout used for laying and filling the joints.

### Expansion joints

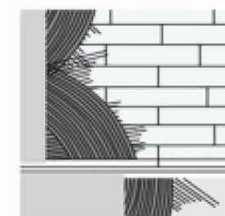
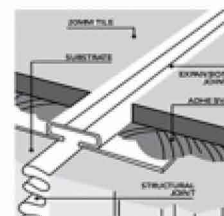

1/2

In correspondence with a structural or dividing joint in the screed, it is mandatory to provide an expansion joint with a width that is at least the size of the existing one. If there are joints between different surface types, it is mandatory to provide an expansion joint.

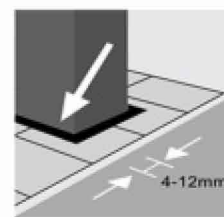

3

Around fixed elements of the supporting structure, such as walls, steps, columns, etc., it is mandatory to provide peripheral joints with a width of between 4 and 12mm.

### CAUTION

The application layers proposed are to be taken as an indication, and have the sole purpose of showing how to obtain a correct flooring. It is recommended to always refer to the specific norms and regulations in each individual country and the instructions of the Project Supervisor.

## ELEVATED FLOOR INSTALLATION

The elevated floor technology offers many specific and immediately perceivable advantages: it allows the passage of cables, pipes and necessary installations to be managed easily; it enables the underfloor to be inspected easily and guarantees an effective draining of rainwater. Thanks to the presence of

independent elements, elevated floors absorb expansion and structural movements, thus avoiding the formation of cracks on the waterproof embrane. The absence of the screed makes it possible to substantially reduce the weight that burdens the structures, while offering a high resistance to loads.

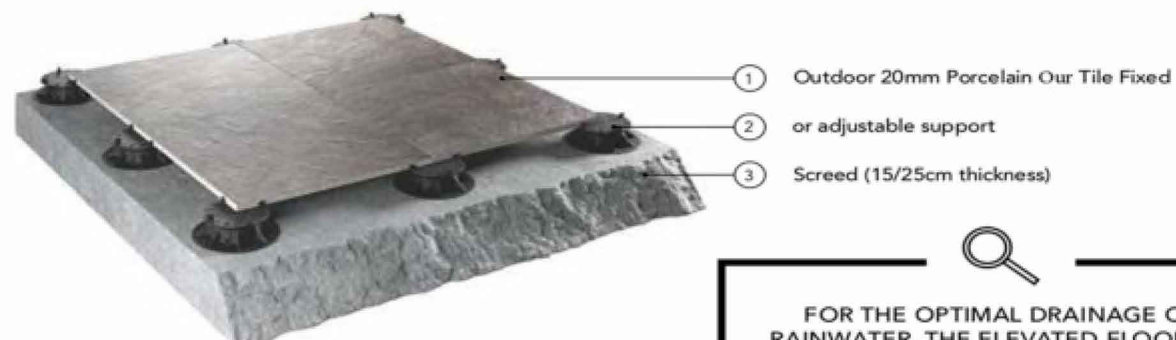

FOR THE OPTIMAL DRAINAGE OF RAINWATER, THE ELEVATED FLOORING MUST BE INSTALLED WITH A SLOPE OF BETWEEN 1.5% AND 2%.

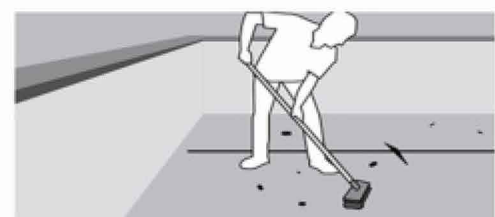

1 The installation on the plastic supports must only be done on perfectly waterproof substrates. Before proceeding with the installation clean the substrate thoroughly.

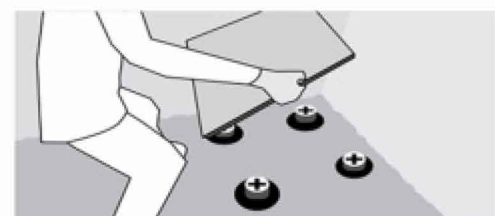

2 With regard to the number and position of the supports, as well as the type of reinforcement on the back of the slab, it is recommended to follow the instructions given in the following table, which are essential to evenly distribute the load.

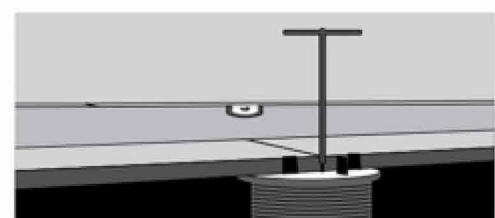

3 With the use of the special adjustment key it is possible to obtain a perfectly stable surface and with the required slope for better water drainage.

### CAUTION

The application layers proposed are to be taken as an indication, and have the sole purpose of showing how to obtain a correct flooring. It is recommended to always refer to the specific norms and regulations in each individual country and the instructions of the project supervisor.

## ELEVATED FLOOR INSTALLATION - SUPPORTS

### Fixed supports and self-levelling adjustable supports

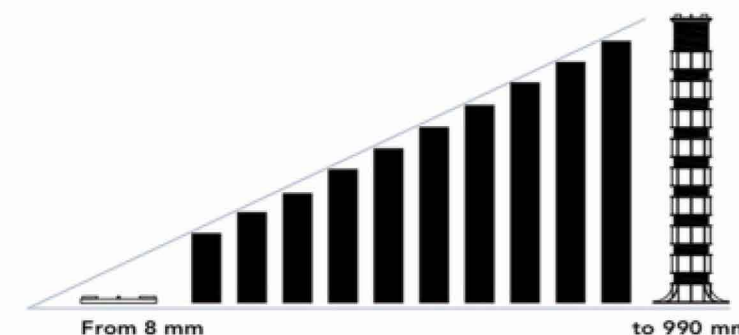

The structure of the supports consists of a base (which rests on the slab), a central screw adjustable in height and a head (on which the tile rests) which can be fixed or self-levelling with a self-adjustment system to alter inclination by up to 5°.

### Technical characteristics of the supports

	They are made entirely of recycled and recyclable material
	Resistant to both acidic and alkaline solutions
	Resistant to atmospheric agents
	Resistant to temperatures of between -30 °C and +120°C
	Resistant to the crushing test with a load superior to 1 tonne
	Made of polypropylene
	Noise reduction of up to 25dB
	Possibility of using supports made with self-extinguishing material, which prevents the propagation of flames

Format	Elevated floor installation up to 2cm	Elevated floor installation 2-10cm	Elevated floor installation 10-30cm	Elevated floor installation 30-99cm
40x60cm	4 SUPPORTS 3=4 sup/m <sup>2</sup>	4 SUPPORTS 3=4 sup/m <sup>2</sup>	4 SUPPORTS + Reinforcement system or substructure of aluminium beams 3=4 sup/m <sup>2</sup>	4 SUPPORTS + Reinforcement system or substructure of aluminium beams 3=4 sup/m <sup>2</sup>
40x90cm	6 SUPPORTS 3=4 sup/m <sup>2</sup>	6 SUPPORTS + Reinforcement system or substructure of aluminium beams 3=4 sup/m <sup>2</sup>	6 SUPPORTS + Reinforcement system or substructure of aluminium beams 3=4 sup/m <sup>2</sup>	6 SUPPORTS + Reinforcement system or substructure of aluminium beams 3=4 sup/m <sup>2</sup>
40x120cm	6 SUPPORTS 3=4 sup/m <sup>2</sup>	6 SUPPORTS + Reinforcement system or substructure of aluminium beams 3=4 sup/m <sup>2</sup>	6 SUPPORTS + Reinforcement system or substructure of aluminium beams 3=4 sup/m <sup>2</sup>	6 SUPPORTS + Reinforcement system or substructure of aluminium beams 3=4 sup/m <sup>2</sup>

## SPECIAL ELEMENTS

In order to guarantee excellent aesthetics and functionality for the various possible applications, the 20mm outdoor porcelain

Our tile collections have a rich set of step elements and special pieces.

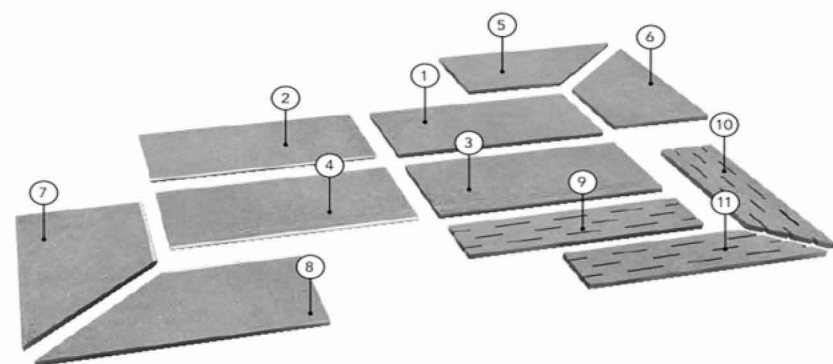

- ① Stair tile with straight edge
- ② Stair tile with rounded edge
- ③ Stair tile with straight ribbed edge
- ④ Stair tile with rounded ribbed edge
- ⑤ Right corner piece with straight edge
- ⑥ Left corner piece with straight edge
- ⑦ Left corner piece with rounded edge
- ⑧ Right corner piece with rounded edge
- ⑨ Grid
- ⑩ Right corner grid
- ⑪ Left corner grid

For the full range of special elements refer to the product catalogue.

### STAIR TILE WITH STRAIGHT EDGE

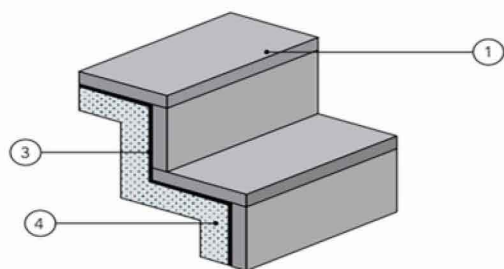

### STAIR TILE WITH ROUNDED EDGE

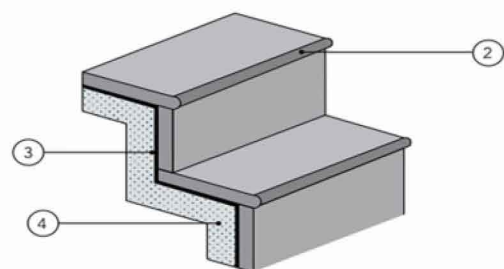

### SWIMMING POOL EDGE

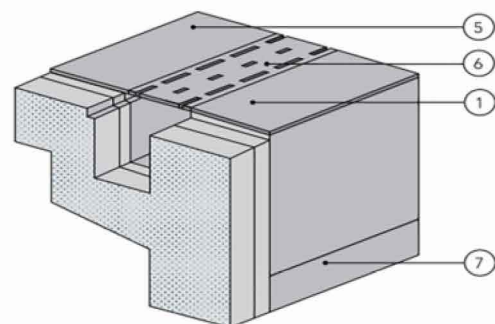

- ① Stair tile with straight edge
- ② Stair tile with rounded edge
- ③ Adhesive
- ④ Screed
- ⑤ Flooring
- ⑥ Grid
- ⑦ Swimming pool covering

### CAUTION

The images are to be taken as an indication, and have the sole purpose of showing how to obtain a correct flooring. It is recommended to always refer to the specific norms and regulations in each individual country and the instructions of the project supervisor.

## TECHNICAL SPECIFICATIONS

TEST DESCRIPTION	ISO-13006/EN176 GROUP BIA	MEAN VALUE OF OUR	TEST METHOD
Length & width	±0.6 %	±0.3mm	Passed
thickness 14mm	±5 %	±0.3mm	Passed
Straightness of side	±0.5 %	±0.3 %	Passed
Rectangularity	±0.6 %	±0.3 %	Passed
Surface flatness	±0.5 %	+0.35mm to -0.1 mm	Passed
Surface quality	Minimum 95 %	Minimum 95 %	Passed
Water absorption	< 0.5 %	< 0.04 %	Passed
Breaking strength	> 1300N	> 1500N	Passed
Flexural strength (Average)	> 35N/mm <sup>2</sup>	> 40N/mm <sup>2</sup>	Passed
Scratch hardness of surface (Moh's scale)	> 6	> 6	Passed
Resistance to deep abrasion	<175mm <sup>3</sup>	<144mm <sup>3</sup>	Passed
Skid Resistance (Friction coefficient)	>0.4	>0.4	Passed
Bulk Density, in (g/cc)	>2	>2	Passed
Linear Thermal expansion	Max. 9.0 <sup>-4</sup> x K <sup>+</sup> , Max	Max. 9.0 <sup>-4</sup> x K <sup>+</sup> , Max	Passed
Thermal shock resistance	No damage	No damage	Passed
Frost resistance	Frost proof	Frost proof	Passed
Resistance to Chemical	Resistance	Resistance	Passed
Resistance to Stain	Resistant	Resistant	Passed
Moisture expansion	Nil	Nil	Passed
Colour resistance	Resistant	Resistant	Passed
Glossiness (Polished)	-	-	Passed

## PACKING DETAILS

SIZE	WEIGHT/ BOX (KG)	PIC/BOX	WEIGHT/ PLT (KG)	BOXES/ PLT	PLT/CTN	BOXES/ CTN	MT <sup>2</sup> /BOX	MT <sup>2</sup> /PLT	MT <sup>2</sup> /CTN	WIGHT/ CTN
600x1200mm (20mm)	32.5	1	30	30	28	840	0.72	21.6	604.8	28000
600x900mm (20mm)	24.5	1	30	40	28	1120	0.54	21.6	604.8	28280
600x600mm (20mm)	32.75	2	30	32	26	832	0.72	23.04	599.04	28028
400x800mm (20mm)	-	-	-	-	-	-	-	-	-	-

## PACKING DETAILS (PATIOPACK)

SIZE	PCS/ CRAT	M2/PCS	SQFT/ PCS	Mt2/ CRATE	SQFT/ CRATE	IN KGS/ CRATE	CRATE/ CTN	CRATE/ CTN	IN KGS/ PLT	IN KGS/ CTN
600x900mm (20mm)	13	0.54	5.81	7.02	75.56	530.40	532.71	36	730	26280
600x600mm (20mm)	13	0.36	3.88	4.68	50.38	235.76				
296x600mm (20mm)	13	0.18	1.94	2.31	25.18	58.14				
296x296mm (20mm)	9	0.09	0.79	0.79	7.10	5.60				
	48			14.80	158.21	829.89	532.71	36.00	730.00	26280.00